

# **Historic Bridge Management Plan for the Atchafalaya Floodway at US 190 Bridges (Eastbound and Westbound)**

**Recall Numbers: 007300 and 007310**

**Structure Numbers: 03490080402331 and 03490080402332**

**Parish: St. Landry**

**Route: US 190**

**Crossing Description: Atchafalaya Floodway**



Prepared for

**Louisiana Department of  
Transportation and  
Development**

Prepared by

**Mead  
& Hunt**

[www.meadhunt.com](http://www.meadhunt.com)

June 2017

**THIS PAGE INTENTIONALLY LEFT BLANK**

# Table of Contents

	Page
<b>Executive Summary .....</b>	<b>1</b>
<b>1. Introduction .....</b>	<b>3</b>
<b>2. Location Map .....</b>	<b>5</b>
<b>3. Historic Data .....</b>	<b>7</b>
A. Identifying information .....	7
B. Description of bridge .....	7
C. History and significance .....	8
D. Character-defining features .....	9
<b>4. Engineering Data.....</b>	<b>13</b>
A. Existing conditions .....	13
(1) Structural observations .....	13
(2) Non-structural observations .....	14
(3) Serviceability observations.....	14
B. Sources of information.....	15
<b>5. Recommendations .....</b>	<b>31</b>
A. Preventative maintenance .....	31
B. Rehabilitation .....	32
C. Identification of any anticipated design exceptions .....	35

## Appendices

- A Historic Inventory Form
- B Select Plan Sheets

**THIS PAGE INTENTIONALLY LEFT BLANK**



## Executive Summary

The Atchafalaya Floodway at US 190 Bridges (Eastbound Recall No. 007310 and Westbound Recall No. 007300) are located in St. Landry Parish, Louisiana, and are owned by the State of Louisiana. These two parallel structures are addressed collectively in this Plan because they are of similar design, materials, and dates of construction, and have similar preservation needs. Relevant differences are noted. The bridges were completed in 1961 as part of a project to construct a series of six high-level bridges over the West Atchafalaya Floodway to carry vehicles over the floodplain.

The bridges were determined eligible for the National Register of Historic Places (National Register) in 2013. They have significance as important crossings of the West Atchafalaya Floodway. In order to continue uninterrupted vehicular access over the floodplain when flooded, the Louisiana Department of Highways (LDH) constructed six high-level bridges (in three pairs) in the 1960s to cross over the floodplain. The bridges at US 190 are the only remaining pair as the other two pairs were replaced in 2004-2005.

These bridges also possess exceptional engineering significance. These parallel structures are the first prestressed-concrete girder bridges constructed by the State. The bridges retain good integrity and continue to convey design features that demonstrate their significance as floodplain crossings and as structures with exceptional significance within their type. The bridges are eligible for the National Register under *Criterion A: Transportation* and *Criterion C: Design/Engineering*.

The two parallel structures each carry two lanes of US 190 traffic in one direction across the West Atchafalaya Floodway in St. Landry Parish. Each structure has a total length of 3,986 feet, 10 inches comprised of 77 spans. The 77 spans are 50-foot, prestressed-concrete girder spans measuring 51 feet, 9 inches from center line of joint to center line of joint. The substructure units for both the westbound and eastbound bridges are reinforced-concrete end bents supported on 24-inch precast concrete piles, and the reinforced-concrete intermediate bent caps are supported on 24-inch precast concrete piles.

The bridges are in satisfactory condition and appear to adequately serve their purpose of carrying vehicular traffic over the waterway. The major deficiencies are cracking and spalling of the concrete approach spans, exposed reinforcing steel on beams and concrete barrier, and erosion and failed slope protection. With proper maintenance and rehabilitation, the Atchafalaya Floodway at US 190 Bridges can continue to serve in their present capacity for 20 years or longer.

Any work on the bridges should proceed according to recommendations in this Historic Bridge Management Plan (Plan), which adhere to the *Secretary of the Interior's Standards for the Treatment of Historic Properties* (Secretary's Standards), the *Management Plan for Historic Bridges Statewide* (Statewide Historic Bridge Plan), and the *Programmatic Agreement among the Federal Highway Administration, the Louisiana Department of Transportation and Development, the Advisory Council on Historic Preservation, and the Louisiana State Historic Preservation Officer Regarding Management of Historic Bridges in Louisiana* (PA).

**THIS PAGE INTENTIONALLY LEFT BLANK**

## 1. Introduction

This Plan, used in conjunction with the Statewide Historic Bridge Plan, provides guidance on the approach to preservation activities for the Atchafalaya Floodway at US 190 Bridges (Eastbound Recall No. 007310 and Westbound Recall No. 007300)<sup>1</sup>, identified as Preservation Priority Bridges. Completion of management plans for Preservation Priority Bridges and the Statewide Historic Bridge Plan fulfills terms of the PA, which was executed on September 21, 2015. These two parallel structures are addressed collectively in this Plan because they are of similar design, materials, and dates of construction and have similar preservation needs. Relevant differences are noted.

The PA provides the basis and procedures for the management of historic bridges in Louisiana and outlines the procedures for the treatment of historic bridges, including Preservation Priority Bridges. In accordance with the PA, an owner seeking state or federal funding for Preservation Priority Bridges will be required by the Louisiana Department of Transportation and Development (LADOTD), in cooperation with the Louisiana State Historic Preservation Office (LASHPO) and the Federal Highway Administration (FHWA), to follow the procedures outlined in this Plan and the Statewide Historic Bridge Plan.

The Statewide Historic Bridge Plan outlines the overall approach to bridge preservation through a discussion of the collaboration of the historian and engineer, guidance on assessing preservation needs, and resources and technical guidance on maintenance and rehabilitation activities that are broadly applicable to historic bridges. A glossary of common engineering and historical terms is included in the Statewide Historic Bridge Plan.

This Plan for the Atchafalaya Floodway at US 190 Bridges summarizes the specific historic and engineering information for these Preservation Priority Bridges. It documents the existing use and condition of the bridges, along with assessments of the preservation needs, including cost estimates. Preservation can be accomplished in two manners: preventative maintenance and rehabilitation. Maintenance includes cyclical or condition-based activities that, along with regular structural inspections, are directed toward continued structure serviceability. Rehabilitation activities are near- or long-term steps that need to be taken to preserve and in some cases restore a bridge's structural condition and serviceability. In assessing preservation activities for each Preservation Priority Bridge, a design life of 20 years was considered, which is consistent with the duration of the PA. This Plan provides the bridge owner, and other interested parties, with detailed information related to the historic nature of the bridges and the necessary background to make an informed planning decision. Recommendations within this Plan should be reviewed in 10 years following completion of the Plan to identify any needed updates or revisions.

---

<sup>1</sup> Recall No. 007310 is also known as the West Atchafalaya Floodway Bridge in the LADOTD's inspection database.

Existing bridge data sources typically available for Louisiana bridges were gathered for this Plan, and field investigation confirmed the general structural condition and character-defining features of the subject bridges. These sources include:

- The current LADOTD Bridge Inspection Report, and any other similar inspection reports
- Original bridge construction plans, any rehabilitation plans, and record as-built plans, as available
- Existing historical and documentary material related to the historic bridges

Recommendations within this Plan are consistent with the Secretary's Standards. The Secretary's Standards are basic principles created to help preserve the distinct character of a historic property and its site, while allowing for reasonable change to meet new engineering standards and codes. The Secretary's Standards recommend repairing, rather than replacing, deteriorated features whenever possible. A version of the Secretary's Standards that is specific to historic bridges is included in the Statewide Historic Bridge Plan. Following these standards is a requirement of the PA.

A bridge historian and bridge engineer from Mead & Hunt, Inc. (Mead & Hunt) jointly prepared this Plan under contract to the LADOTD. The LADOTD, FHWA, and LASHPO reviewed and provided input into the final Plan.

## 2. Location Map

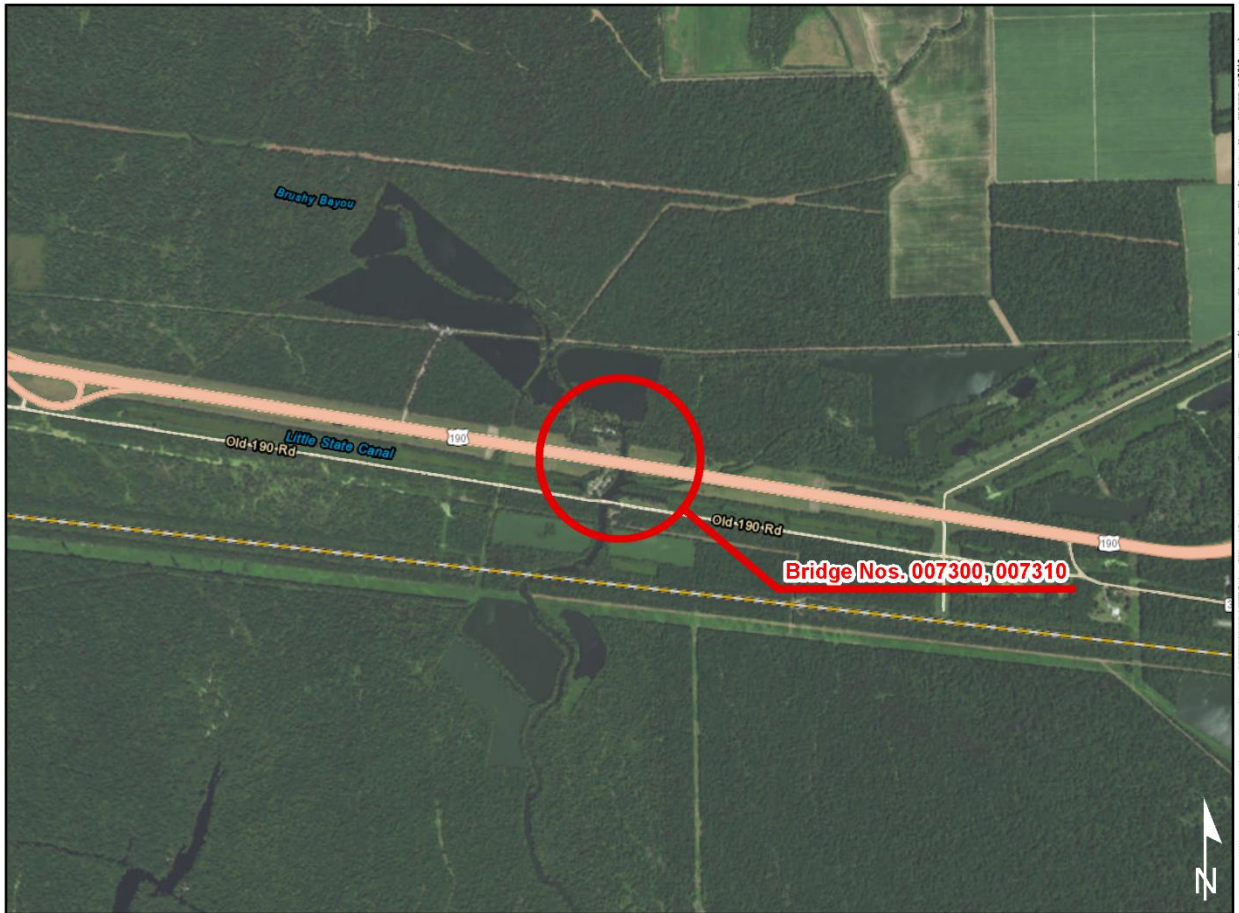

0 1,250 2,500 5,000 Feet

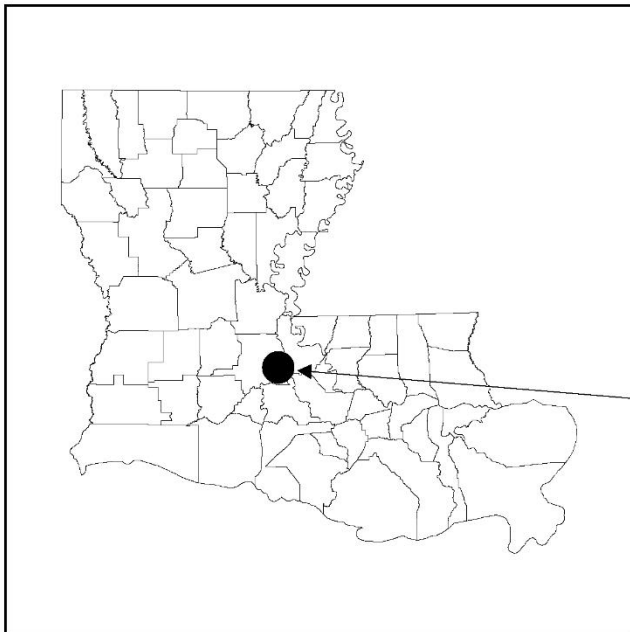

**PROJECT LOCATION**  
Bridge Number: 007300, 007310  
Stucture Number: 03490080402331, 03490080402332  
St. Landry Parish  
Route: LA 170  
Crossing Description: Atchafalaya Floodway

**THIS PAGE INTENTIONALLY LEFT BLANK**

### 3. Historic Data

#### A. Identifying information

**Structure Number:** 03490080402331 and 03490080402332

**Recall Number:** 007300 and 007310

**LASHPO Number:** 49-00001 and 49-00002

**Bridge Name:** Atchafalaya Floodway at US 190 Bridges (eastbound and westbound)

**Date of Construction:** 1961 (both)

**Main Span Type:** Post-1945 common type – Prestressed-concrete girder

**Contractor:** R. H. Wright, Inc., Fort Lauderdale, Fla. (prestressed beams)  
Blount Brothers Construction Company, Montgomery, Ala.

**Designer/Engineer:** Louisiana Department of Highways

#### B. Description of bridge

The Atchafalaya Floodway Bridges (eastbound and westbound) carry four lanes of US 190 across the West Atchafalaya Floodway in St. Landry Parish. The two parallel structures each carry two lanes of traffic in one direction. Each structure has a total length of 3,986 feet, 10 inches comprised of 77 spans. The 77 spans are 50-foot, prestressed-concrete girder spans measuring 51 feet, 9 inches from center line of joint to center line of joint. The distance between the centerline of end bents and the beginning and ending of bridge is 1 foot, ½ inch. The substructure units for both the westbound and eastbound bridges are reinforced-concrete end bents supported on 24-inch precast concrete piles, and the reinforced-concrete intermediate bent caps are supported on 24-inch precast concrete piles.

The average daily traffic (ADT) across each bridge is approximately 7,260 vehicles. Neither bridge is load (weight) posted.

The eastbound bridge was rehabilitated in 1982. The rehabilitation included re-decking, the elimination of select expansion joints by providing 21 continuous span units, adding a new girder line to widen the bridge, extension of the end bents and intermediate bents, adding restrictive devices on bearings and constructing new approach slabs. The westbound bridge was rehabilitated in 1974. The rehabilitation included re-decking, extension of select intermediate bents, adding restrictive devices on bearings, and construction of new approach slabs. As part of both rehabilitation projects, 18-inch battered precast concrete piles were added to select intermediate bents.



The eastbound bridge has a clear roadway width of 37 feet, 5 inches, which provides for two 12-foot lanes of traffic, both in the eastbound direction, with a 10-foot shoulder to the south and a 3-foot, 5-inch shoulder to the north. The westbound bridge has a clear roadway width of 30 feet, 5-3/4 inches, which provides for two 12-foot lanes of traffic, both in the westbound direction, with a 3-foot, 2-7/8-inch shoulder to the south and north. Both bridges have 2-foot, 8-inch-tall reinforced-concrete barriers as the bridge railing that is not original to the structures.

### C. History and significance

The Atchafalaya Floodway Bridges at US 190 were part of a post-World War II era bridge program related to flood management. The project included the construction of a series of six high-level bridges, built in three pairs in the 1960s over the West Atchafalaya Floodway to carry vehicles over the floodplain.<sup>2</sup> The Atchafalaya River, one of the principal rivers in the state, is a controlled “distributary” of the Mississippi River and carries flow from the Red, Mississippi, and Ouachita Rivers to the Gulf of Mexico. The Atchafalaya Floodway Bridges at US 190 are the only two of the six original bridges that remain.

In 1960 a federal appropriation of \$6,000,000 was awarded to Louisiana for the Atchafalaya Basin in connection with the continuing dredging and levee-building program in the greater New Orleans area and southern Louisiana. The funding would include the beginning of the construction of bridges to carry US 190 over the flood waters on the west side of the Atchafalaya River.<sup>3</sup>

The Atchafalaya Floodway Bridges (six bridges in three pairs) were the first Louisiana Department of Highway (LDH)-designed prestressed-concrete girder bridges in the state.<sup>4</sup>

The final tracings for the bridges show two layout options: one using reinforced-concrete girders and one using prestressed-concrete girders. This demonstrates the transition in use of materials during this time. The Atchafalaya Floodway Bridges at US 190 were rehabilitated in 1974 (eastbound) and 1982 (westbound) including widening of the eastbound bridge with additional prestressed girders. The original lightweight bridge decks were replaced on both bridges.

The Atchafalaya Floodway Bridges at US 190 have significance for their association with important trends or events that have made a significant contribution to the broad patterns of Louisiana history. Their significance is demonstrated in the area of Transportation as important crossings of the West Atchafalaya Floodway. In order to continue uninterrupted vehicular access over the floodplain when flooded, the LDH constructed six high-level bridges (in three pairs) in the 1960s to cross over the floodplain. The

---

<sup>2</sup> Louisiana Department of Highways, “West Atchafalaya Floodway Crossing Bridges” plans prepared by the Department of Highways 1958, available from the Louisiana Department of Transportation and Development, Baton Rouge, La.

<sup>3</sup> “Appropriations will aid N.O.,” *The Times Picayune*, May 25, 1960, 4.

<sup>4</sup> Louisiana Department of Transportation and Development, Master Structure File Database; James Porter, LADOTD, email to Robert M. Frame, Mead & Hunt, Inc., September 11, 2012.



Atchafalaya Floodway Bridges at US 190 are the only remaining pair as the other two pairs were replaced in 2004-2005.

These bridges also possess exceptional engineering significance. These parallel structures are the first prestressed-concrete girder bridges constructed by the State. Plans were approved in 1958 and the bridges were constructed in 1961, during the early period of prestressed concrete use in Louisiana. The bridges retain good integrity and continue to convey design features that demonstrate their significance as floodplain crossings and as structures with exceptional significance within their type. The bridges are eligible for the National Register under *Criterion A: Transportation* and *Criterion C: Design/Engineering*.

#### **D. Character-defining features**

Character-defining features are prominent or distinctive aspects, qualities, or characteristics of a historic property that contribute significantly to its physical character. Features may include materials, engineering design, and structural and decorative details. Elements of the bridge that are not identified as character-defining features may be historic fabric. Historic fabric is material in a bridge that was part of original construction. It is important to consider both character-defining features and the bridge's historic fabric when planning any work.

The Atchafalaya Bridges each have one character-defining feature: their prestressed concrete girder superstructures (described below). Another element that represents historic fabric for each bridge but is not considered to be character-defining is the bridge's substructure. The bridges have reinforced-concrete barrier bridge railings. These are not original to the structure and therefore are not considered to be historic fabric. The added girder on the eastbound structure is also an addition and, as such, is not historic fabric.

The following item is the character-defining features of this bridge:

##### **Feature 1: Design and construction of the prestressed concrete girders**

This feature includes the 77, 50-foot prestressed-concrete girder main spans.



*Character-defining Feature Photo 1: Prestressed concrete girder superstructure (Recall No. 007300).*



*Character-defining Feature Photo 2: Prestressed concrete girder superstructure (Recall No. 007310).*



*Character-defining Feature Photo 3: Detail of prestressed concrete girder superstructures (Recall No. 007300 on left and Recall No. 007310 on right).*



The following images illustrate other bridge features that are historic fabric, meaning they are part of original construction but are not considered to be character-defining features:



*Historic Fabric Photo 1: Substructure (Recall No. 007300).*



*Historic Fabric Photo 2: Substructure (Recall No. 007310).*

## 4. Engineering Data

### A. Existing conditions

#### (1) Structural observations

The Atchafalaya Floodway at US 190 Bridges (eastbound and westbound) are both in overall satisfactory condition and appear to adequately serve their purpose of carrying vehicular traffic over the waterway. The bridges are not load (weight) posted.

##### *Eastbound bridge (Recall No. 007310)*

The eastbound superstructure is in satisfactory condition. The reinforced-concrete deck is in overall satisfactory condition with transverse cracks on the top of deck. Additionally, the top of the deck in spans 73 and 74 have map cracking and spalls beginning to form and multiple pop-outs in span 47, up to 6 inches in diameter and 1-1/4 inches in depth. On the underside of the deck there are diagonal and transverse cracks with efflorescence and dirt daubers nests. The shoulders of the deck are covered with minimal debris. The prestressed-concrete beams are in overall good condition. Span 1, beam 1 has graffiti and span 44, beam 3 has a spalled area on the top of the beam. The diaphragms between beams are in good condition. The diaphragm between beams 2 and 3 at span 66 exhibits spalling with exposed reinforcing. Additionally, the diaphragm between beams 3 and 4 at spans 3, 17, and 21 exhibit spalling with exposed reinforcing. The compression joint seals are in fair condition. Numerous compression joints have failed and the backer rod of the joints are sitting on the bent cap seat. The elastomeric bearings are in good condition. The moveable bearings are in satisfactory condition with restriction devices installed at numerous bearings. Additionally, a number of the sole plates are corroded and the bearing at girder 5, bent 11, span 12; girder 4, bent 4, span 4; and girder 3, bent 8, span 8 are beginning to slip out and the anchor bolt nuts have begun to back off the bolts at the end bents. The reinforced-concrete barrier is in satisfactory condition, with numerous spalled areas with exposed reinforcing, water staining, and minor vehicular collision damage.

The eastbound substructure is in satisfactory condition. The end bents are in satisfactory condition. The soil on the north side of end bent 1 has waterway erosion and the precast concrete pile is exposed, debris build up on the seats, and the reinforced-concrete cap of the end bent is spalled. End bent 78 has an exposed precast concrete pile and the backwall has minor cracking. The reinforced-concrete intermediate bent caps are in good condition. The intermediate bent caps have water staining and bent 9 end is spalled. The reinforced-concrete intermediate bent columns are in satisfactory condition. The intermediate bent columns exhibit hairline cracks, spalls, and vegetation growth. The concrete slope protection is in poor condition. End bent 1 and end bent 78 slope protection has failed. The slope protection at both end bents are covered with heavy vegetation.

*Westbound bridge (Recall No. 007300)*

The westbound superstructure is in satisfactory condition. The reinforced-concrete deck is in overall satisfactory condition with transverse cracks with efflorescence and dirt dauber nest on the underside of the concrete deck slab. The top of the deck has hairline cracks throughout and the shoulders of the deck are covered with minimal debris. The prestressed-concrete beams are in overall good condition. Beam 5 at end bent 1 has a longitudinal crack. The north exterior beam is exhibiting water staining from the scupper holes in the deck, and in span 77 the south exterior beam has graffiti. The diaphragms between beams are in good condition, with minor cracks between beams 1 and 2 at the middle of spans 1 and 77. The compression joint seals are in poor condition. Numerous compression joints have failed and the backer rod of the joints are sitting on the bent cap seat. The expansion and fixed bearings are in satisfactory condition. The restriction devices are corroded, numerous are bent, and the connection nuts are corroded with 50 percent section loss. The reinforced-concrete barrier is in good condition, with one large spalled area with exposed reinforcing in span 6 and one large spalled area with exposed reinforcing in span 77. The barrier has water staining, hairline cracks, and minor vehicular collision damage throughout.

The westbound substructure is in good condition. The end bents are in satisfactory condition. End bent 1 has undermining causing the bottom of the end bent to be exposed. The south side of end bent 78 has vertical cracks and spalls on the backwall with exposed reinforcing. Additionally, end bent 78 exhibits water staining. There is heavy debris on the end bent seats. The reinforced-concrete intermediate bent caps are in good condition with minor water staining. The reinforced-concrete intermediate bent columns are in good condition with hairline cracks and vegetation growth. The concrete slope protection at the end bents is in poor condition. End bent 1 has failed and the end bent 78 slope protection is cracking. The slope protection at both end bents are covered with heavy vegetation.

**(2) Non-structural observations**

The reinforced-concrete approach slabs for both bridges have been overlaid with asphalt and are in satisfactory condition with no major deficiencies.

**(3) Serviceability observations**

The ADT across for each bridge is 7,260 vehicles. The eastbound bridge clear roadway width of 37 feet, 5 inches provides for two lanes of traffic, both in the eastbound direction, with a 10-foot shoulder to the south and a 3-foot, 5-inch shoulder to the north. The westbound bridge clear roadway width of 30 feet, 5-3/4 inches provides for two lanes of traffic, both in the westbound direction, with a 3-foot, 2-7/8-inch shoulder to the south and north. The bridges appear to adequately handle this traffic volume. The horizontal and vertical geometry of the bridge is good. The railing on the bridges are reinforced-concrete barrier.

**B. Sources of information**

**Plans available:** Yes, available at the LADOTD Bridge Section office

**Inspection report date:** February 10, 2016 (Recall No. 007300) and February 8, 2016 (Recall No. 007310)

**Fracture critical report date:** Not applicable for this bridge

**Underwater inspection report:** Not applicable for this bridge

**Date of site visit:** February 4, 2016

*Condition photographs of the eastbound bridge (Recall No. 007310)*



*Condition Photo 1: West roadway approach looking east.*





*Condition Photo 2: East roadway approach looking east.*



*Condition Photo 3: Elevation view looking west.*





*Condition Photo 4: Typical top of deck roadway surface looking east.*



*Condition Photo 5: Concrete spall on barrier and typical debris on shoulder.*



*Condition Photo 6: Elevation of bents from between the two bridges showing the extension of the bents for both bridges.*



*Condition Photo 7: Typical vegetation growth on the concrete slope protection.*





*Condition Photo 8: Typical vegetation growth on the substructure units and part of the superstructure.*



*Condition Photo 9: Erosion and exposed precast concrete pile at end bent 1 and failed concrete slope protection.*





*Condition Photo 10: Debris and vegetation on the end bent 1 seat and the failed compression seal strip.*



*Condition Photo 11: Horizontal cracks on the end bent 78 backwall, dirt daubers on the concrete beams, and debris and vegetation on the beam seat.*



*Condition Photo 12: Concrete spall on intermediate precast concrete bent pile.*



*Condition Photo 13: Failed compression joint and failed concrete slope protection.*





*Condition Photo 14: Dirt dauber on the underside of the superstructure and cracking with efflorescence.*



*Condition Photo 15: Corrosion on the bearing assembly on the bents, typical.*

Condition photographs of the westbound bridge (Recall No. 007300)



Condition Photo 16: West roadway approach looking west.



Condition Photo 17: East roadway approach looking west.





*Condition Photo 18: Elevation view looking east.*



*Condition Photo 19: Spall in concrete deck overhang.*





*Condition Photo 20: North concrete barrier collision damage with exposed steel.*



*Condition Photo 21: Collision damage and exposed concrete on the barrier terminal wall.*



*Condition Photo 22: Typical vegetation growth on the concrete slope protection.*



*Condition Photo 23: Typical vegetation growth on the substructure units.*





*Condition Photo 24: Erosion and exposed bottom of end bent 1 and failed concrete slope protection.*



*Condition Photo 25: Concrete spalled end bent 78 on the south side.*



*Condition Photo 26: Dirt dauber nests on the underside of the superstructure and cracking with efflorescence.*



*Condition Photo 27: Typical graffiti on the south exterior concrete beam, span 77.*





*Condition Photo 28: Cracked concrete diaphragm between concrete beams, typical.*



*Condition Photo 29: Typical expansion joint failure.*



*Condition Photo 30: Rusted steel bearing assembly, typical.*



*Condition Photo 31: Typical corroded bearing restriction device.*



## 5. Recommendations

These Preservation Priority Bridges should remain in use and can meet current and projected transportation needs for the next 20 years or more. Maintenance and rehabilitation activities should be completed in a manner consistent with the long-term preservation of these historic bridges. The Statewide Historic Bridge Plan provides additional guidance and approaches to completing maintenance and rehabilitation activities that adhere to the Secretary's Standards. Work should be conducted under the supervision of a qualified professional historian, as defined in the PA. The bridge engineer, or the bridge engineer's supervising engineer, should have demonstrated expertise in historic bridge projects and must have completed the LADOTD's historic bridge training. When developing plans and specifications for a project, the bridge engineer should follow the recommendations below.

Under the terms agreed upon in the PA, the bridge owner may undertake certain activities that are considered to be best practices without additional consultation or public notification. These activities are documented in Attachment 5 of the PA and are limited to the activities specifically noted. All recommended preventative maintenance and rehabilitation activities for these bridges are included in Attachment 5 and are not expected to alter character-defining features or historic fabric of the bridges. Some cyclical or condition-based maintenance items are noted below under Rehabilitation because they are expected to be completed as part of an overall rehabilitation project for these bridges. These activities may need to be completed as conditions dictate to promote long-term preservation of these historic bridges. Recommendations within this Plan should be reviewed in 10 years following completion of the Plan to identify any needed updates or revisions.

The opinions of probable costs provided below are in 2016 dollars. The costs were developed without benefit of preliminary rehabilitation plans and are based on the above identified tasks using engineering judgment and/or gross estimates of quantities and historic unit prices and are intended to provide a programming level of estimated costs. Refinement of the probable costs is recommended once preliminary plans have been developed. The estimated preservation costs include a 10% contingency and 7% mobilization allowance of the preservation activities, excluding soft costs. Actual costs may vary significantly from those opinions of cost provided herein. Engineering design, historical consultation, and construction administration costs are not included as these may be provided by the owner or consultants.

### A. Preventative maintenance

The following are recommendations for cyclical maintenance. Because these activities are routinely done, the cost is not included in the cost estimate. There are no condition-based maintenance recommendations at this time, based on the bridges condition as observed during the site visit and as documented in available information.

#### *Eastbound bridge (Recall No. 007310)*

1. Remove vegetation and debris from substructure units and slope protection regularly to maintain good condition.
2. Remove debris from top of concrete deck and shoulders, as necessary.

*Westbound bridge (Recall No. 007300)*

1. Remove vegetation and debris from substructure units and slope protection regularly to maintain good condition.
2. Remove debris from top of concrete deck and shoulders, as necessary.

**B. Rehabilitation**

The following are recommendations for rehabilitation. These activities should be performed when necessary (expected to be within the next five years):

*Eastbound bridge (Recall No. 007310)*

1. Clean concrete units to remove dirt daubers on the concrete beams and underside of deck.
2. Repair cracks on the end bent 78 with epoxy injections.
3. Repair spall and cracks on bent columns with concrete patches and epoxy injections, respectively. The concrete used for the repair should match the color, texture and consistency of the adjacent existing concrete.
4. Clean the exposed reinforcing steel and repair the concrete spalls on the intermediate concrete diaphragms, in a manner that the concrete used for the repair matches the color, texture, and consistency of the adjacent existing concrete.
5. Clean the exposed reinforcing steel and repair the concrete spall on the top of beam 3, span 44, in a manner that the concrete used for the repair matches the color, texture, and consistency of the adjacent existing concrete.
6. Repair the concrete spall on the cap of bent 9, in a manner that the concrete used for the repair matches the color, texture, and consistency of the adjacent existing concrete.
7. Clean and paint the sole plates on the bearing assemblies.
8. Tighten the anchor bolt nuts at end bents 1 and 78.
9. Repair erosion at end bents 1 and 78 with non-erodible material.
10. Remove and repair the failed slope protection at end bents.
11. Remove and replace expansion joint material, as necessary.



- 12. Clean the exposed reinforcing steel in the concrete barrier and repair the spalled concrete.
- 13. Repair the spalled and pop outs on the concrete deck.

Bridge Recall No. 007310				Date:	11/11/2016	
Atchafalaya Floodway at US 190 Bridges						
Opinion of Probable Costs						
Rehabilitation						
	<b>Item</b>	<b>Quantity</b>	<b>Unit</b>	<b>Unit Cost</b>	<b>Total</b>	
	Clean concrete units to remove dirt daubers on the concrete beams and underside of deck.	1	LS	\$50,000	\$50,000	
	Repair cracks on the end bent 78 with epoxy injections.	1	LS	\$10,000	\$10,000	
	Repair spall and cracks on bent columns with concrete patches and epoxy injections, respectively. The concrete used for the repair should match the color, texture, and consistency of the adjacent existing concrete.	1	LS	\$250,000	\$250,000	
	Clean the exposed reinforcing steel and repair the concrete spalls on the intermediate concrete diaphragms, in a manner that the concrete used for the repair matches the color, texture, and consistency of the adjacent existing concrete.	1	LS	\$50,000	\$50,000	
	Clean the exposed reinforcing steel and repair the concrete spalls on the top of beam 3, span 44, in a manner that the concrete used for the repair matches the color, texture, and consistency of the adjacent existing concrete.	1	LS	\$10,000	\$10,000	
	Repair the concrete spall on the cap of bent 9.	1	LS	\$10,000	\$10,000	
	Clean and paint the sole plates on the bearing assemblies.	1	LS	\$100,000	\$100,000	
	Tighten the anchor bolt nuts at end bents 1 and 78.	12	EA	\$1,000	\$12,000	
	Repair erosion at end bents 1 and 78 with non-erodible material.	2	LS	\$5,000	\$10,000	
	Remove and repair the failed slope protection at end bents.	2	LS	\$25,000	\$50,000	
	Remove and replace expansion joint material, as necessary.	880	LF	\$50	\$44,000	
	Clean the exposed reinforcing steel in the concrete barrier and repair the spalled concrete.	1	LS	\$10,000	\$10,000	
	Repair the spalled and pop outs on the concrete deck.	1	LS	\$50,000	\$50,000	
	Traffic control, signage and drums.	1	LS	\$25,000	\$25,000	
	Item Subtotal				\$681,000	
	Contingency			10.00%	\$68,100	
	Mobilization			7.00%	\$52,437	
<b>TOTAL ESTIMATED CONSTRUCTION COST</b>						
					<b>\$801,537</b>	
				<b>Round to:</b>	<b>\$802,000</b>	

*Westbound bridge (Recall No. 007300)*

1. Clean concrete units to remove dirt daubers on the concrete beams and underside of deck.
2. Repair cracks and spalls on the end bent 78 backwall, intermediate bent columns, and intermediate concrete diaphragms with epoxy injections and concrete patches, respectively. The concrete used for the repair should match the color, texture, and consistency of the adjacent existing concrete.
3. Repair erosion at end bent 1 with non-erodible material.
4. Remove and repair the failed and cracked slope protection at end bents, as necessary.
5. Remove and replace expansion joint material, as necessary.
6. Clean the exposed reinforcing steel in the concrete barrier and repair the spalled concrete, in a manner that the concrete used for the repair matches the color, texture, and consistency of the adjacent existing concrete.
7. Clean the corrosion on the restricting devices and replace the nuts corroded more than 50 percent and paint restricting devices.
8. Repair the longitudinal crack on beam 5 at end bent 1.

Bridge Recall No. 007300			Date:	11/11/2016
Atchafalaya Floodway at US 190 Bridges				
Opinion of Probable Costs				
Rehabilitation				
Item	Quantity	Unit	Unit Cost	Total
Clean concrete units to remove dirt daubers on the concrete beams and underside of deck.	1	LS	\$50,000	\$50,000
Repair cracks and spalls on the end bent 78 backwall, intermediate bent columns, and intermediate concrete diaphragms with epoxy injections and concrete patches, respectively. The concrete used for the repair should match the color, texture and consistency of the adjacent existing concrete.	1	LS	\$300,000	\$300,000
Repair erosion at end bent 1 with non-erodible material.	1	LS	\$5,000	\$5,000
Remove and repair the failed and cracked slope protection at end bents, as necessary.	2	LS	\$25,000	\$50,000
Remove and replace expansion joint material, as necessary.	3,160	LF	\$50	\$158,000
Clean the exposed reinforcing steel in the concrete barrier and repair the spalled concrete, in a manner that the concrete used for the repair matches the color, texture, and consistency of the adjacent existing concrete.	1	LF	\$10,000	\$10,000
Clean the corrosion on the restricting devices and replace the nuts corroded more than 50 percent and paint restricting devices.	1	LS	\$100,000	\$100,000
Repair the longitudinal crack on beam 5 at end bent 1.	1	LS	\$25,000	\$25,000
Traffic control, signage and drums	1	LS	\$25,000	\$25,000
Item Subtotal				\$723,000
Contingency			10.00%	\$72,300
Mobilization			7.00%	\$55,671
<b>TOTAL ESTIMATED CONSTRUCTION COST</b>				<b>\$850,971</b>
			Round to:	<b>\$851,000</b>

**C. Identification of any anticipated design exceptions**

No design exceptions were noted, nor are any design exceptions recommended.

**THIS PAGE INTENTIONALLY LEFT BLANK**



**Appendix A. Historic Inventory Form**

**THIS PAGE INTENTIONALLY LEFT BLANK**

# Louisiana Historic Bridge Inventory

Recall Number: 007300

Structure Number: 03490080402331

SHPO Number: 49-00001

## Bridge Name:

### Location Data:

District: 03

Parish: St. Landry

Feature Crossed: ATCHAFALAYA FLOODWAY

Facility Carried: US0190

Location: 2.0 MI EAST OF LA 975

City, Village or Town (if applicable):

Status: Open

Bridge Owner: State of Louisiana

Latitude: 30.541542

Longitude: -91.784023

---

### Structural Data:

Bridge Type: Concrete Prestressed Girders

Year Built: 1961

Main Span Configuration (if applicable):

Maximum Span Length (feet): 52

Number of Spans: 77

Overall Structure Length (feet): 3984

Approach Span Type (if applicable): N/A

Posted Load:

Current ADT: 008040

---

### Design and Construction Data:

Engineer or Builder:

Unknown

Bridge Plaque:

None

---

### National Register of Historic Places Evaluation:

This prestressed concrete girder bridge has significance for its association with important trends or events that have made a significant contribution to the broad patterns of Louisiana history. Its significance is demonstrated in the area of Transportation as an important crossing of the West Atchafalaya Floodway. In order to continue uninterrupted vehicular access over the floodplain when flooded, the state constructed six high-level bridges (in three pairs) in the 1960s to cross over the floodplain, including this bridge and its parallel structure (Recall No. 007310). This is one-half of the only remaining pair of bridges as the other two pairs were replaced in 2004-2005. This bridge and its parallel structure provided uninterrupted access across the West Atchafalaya Floodway.

Although constructed in 1961 and considered a common type, this bridge possesses exceptional engineering significance. This bridge and its parallel structure are the first prestressed concrete girder bridges constructed by the state. Plans were approved in 1958 and the bridges were constructed in 1961, during the early period of prestressed concrete use in Louisiana. This bridge retains good integrity and continues to convey design features that demonstrate its significance as a floodplain crossing and as a structure with exceptional significance within its type. This bridge is eligible for listing in the National Register under Criterion A: Transportation and Criterion C: Design/Engineering.

---

Within/Adjacent to Known Historic District: N/A

National Register Historic District Name: N/A

National Register Determination: Eligible

National Register Determination Date: 2013

Surveyor: Mead & Hunt, Inc.

Date Surveyed: 2013



# Louisiana Historic Bridge Inventory

Recall Number: 007300

Structure Number: 03490080402331

Bridge Name:

Parish: St. Landry

Bridge Owner: State of Louisiana

Feature Crossed: ATCHAFALAYA FLOODWAY

Facility Carried: US0190

---

## Photographs:





# Louisiana Historic Bridge Inventory

Recall Number: 007310

Structure Number: 03490080402332

SHPO Number: 49-00002

Bridge Name: WEST ATCHAFALAYA FLOODWY

## Location Data:

District: 03

Parish: St. Landry

Feature Crossed: ATCHAFALAYA FLDWY

Facility Carried: US0190

Location: 2.0 MI EAST OF LA 975

City, Village or Town (if applicable):

Status: Open

Bridge Owner: State of Louisiana

Latitude: 30.541139

Longitude: -91.783972

## Structural Data:

Bridge Type: Concrete Prestressed Girders

Year Built: 1961

Main Span Configuration (if applicable):

Maximum Span Length (feet): 50

Number of Spans: 77

Overall Structure Length (feet): 3984

Approach Span Type (if applicable): N/A

Posted Load:

Current ADT: 008040

## Design and Construction Data:

Engineer or Builder:

Unknown

Bridge Plaque:

None

## National Register of Historic Places Evaluation:

This prestressed concrete girder bridge has significance for its association with important trends or events that have made a significant contribution to the broad patterns of Louisiana history. Its significance is demonstrated in the area of Transportation as an important crossing of the West Atchafalaya Floodway. In order to continue uninterrupted vehicular access over the floodplain when flooded, the state constructed six high-level bridges (in three pairs) in the 1960s to cross over the floodplain, including this bridge and its parallel structure (Recall No. 007300). This is one half of the only remaining pair of bridges as the other two pairs were replaced in 2004-2005. This bridge and its parallel structure and provided uninterrupted access over the West Atchafalaya Floodway.

Although constructed in 1961 and considered a common type, this bridge also possesses exceptional engineering significance. This bridge and its parallel structure, which is nearly identical, are the first prestressed concrete girder bridges constructed by the state. Plans were approved in 1958 and the bridges were constructed in 1961, during the early period of prestressed concrete use in Louisiana. The bridge, which carries eastbound US 190 traffic over the Atchafalaya Spillway, was widened in 1974 with the addition of a new concrete girder on the outside of the structure. However, the design and materials are sympathetic to the original bridge design and it does not detract from the integrity. Despite this alteration, this bridge retains good integrity and continues to convey design features that demonstrate its significance as a floodplain crossing and as a structure with exceptional significance within its type. This bridge is eligible for listing in the National Register under Criterion A: Transportation and Criterion C: Design/Engineering.

Within/Adjacent to Known Historic District: N/A

National Register Historic District Name: N/A

National Register Determination: Eligible

National Register Determination Date: 2013

Surveyor: Mead & Hunt, Inc.

Date Surveyed: 2013



# Louisiana Historic Bridge Inventory

Recall Number: 007310

Structure Number: 03490080402332

Bridge Name: WEST ATCHAFALAYA FLOODWY

Parish: St. Landry

Bridge Owner: State of Louisiana

Feature Crossed: ATCHAFALAYA FLDWY

Facility Carried: US0190

## Photographs:



**Appendix B. Select Plan Sheets**

**THIS PAGE INTENTIONALLY LEFT BLANK**



NOTE:  
Existing Shoulder Drain  
to be Removed. (No direct Payment)

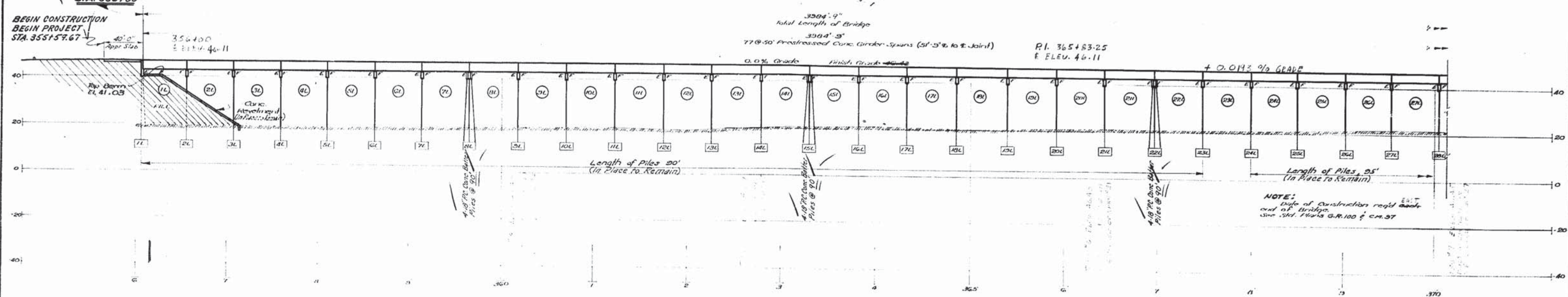
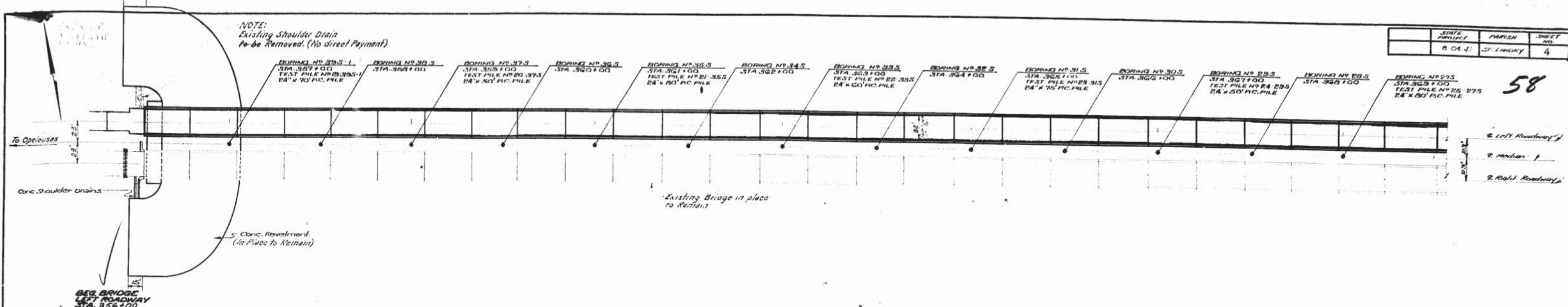

PROFILE OF LEFT ROADWAY ALONG 2 ROADWAY  
STATIONING ALONG 2 ROADWAY

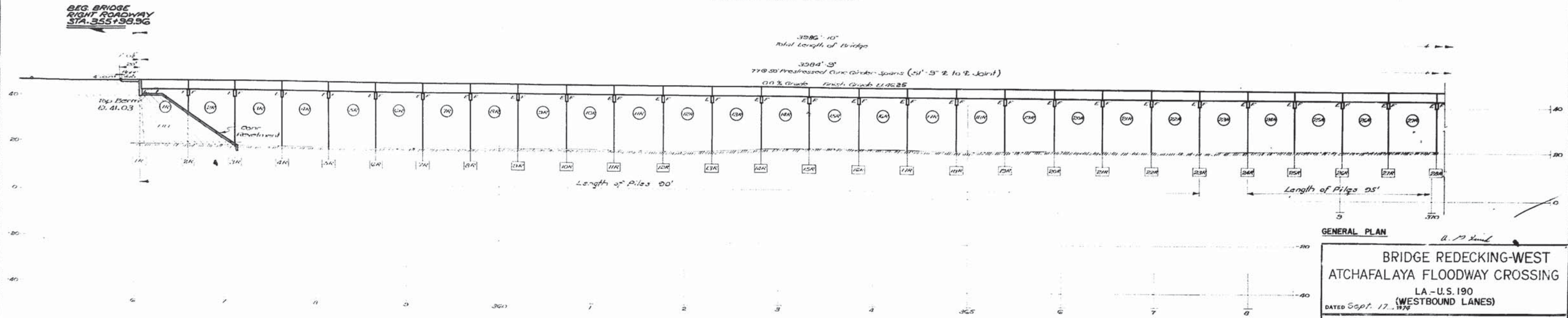

PROFILE OF RIGHT ROADWAY ALONG 2 OF ROADWAY  
STATIONING ALONG 2 ROADWAY  
(IN PLACE TO REMAIN)

GENERAL PLAN

BRIDGE REDECKING-WEST  
ATCHAFALAYA FLOODWAY CROSSING  
LA - U.S. 190  
(WESTBOUND LANES)  
DATED Sept. 17, 1976

STATE OF LOUISIANA  
DEPARTMENT OF HIGHWAYS

DESIGNED	DETAILED R. Montequo	TRACED M.J.
CHECKED	CHECKED R. J. ...	CHECKED

BRIDGE DESIGN SECTION



STATE PROJECT	PARISH	SHEET NO.
A. 10-1	ST. LANDRY	5

59

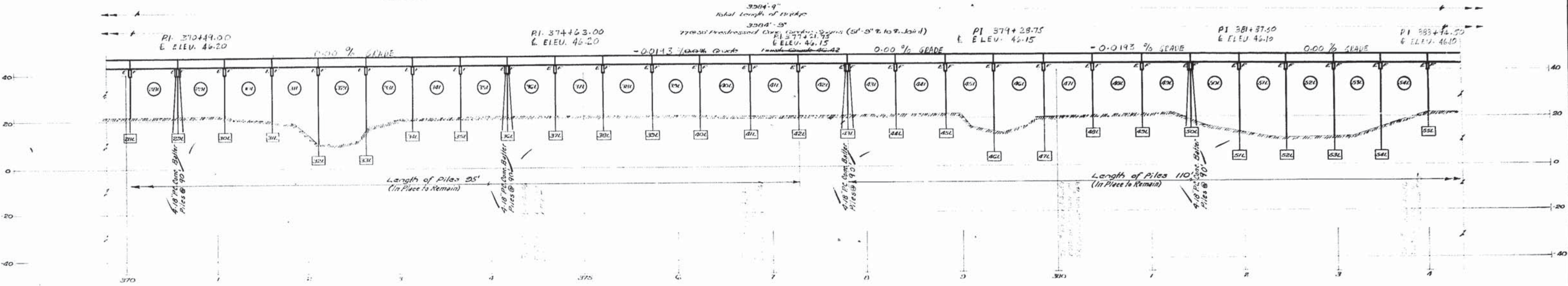
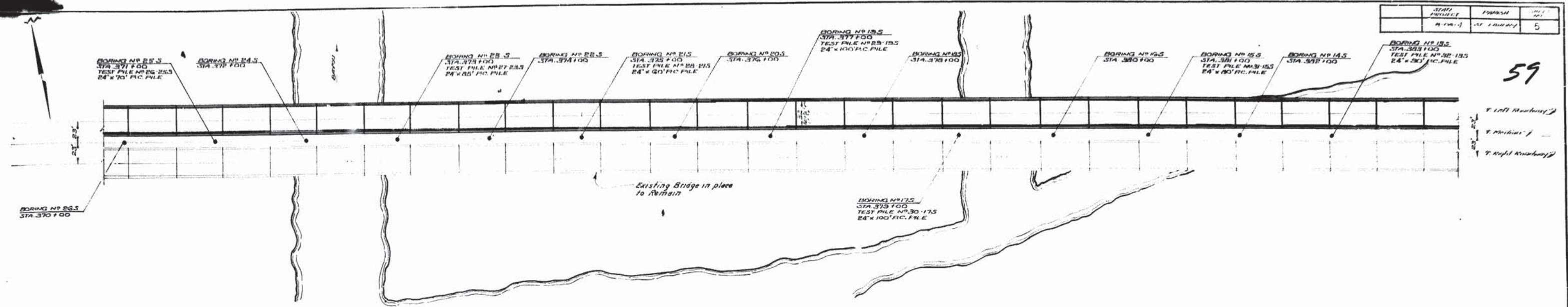

PROFILE OF LEFT ROADWAY ALONG E ROADWAY  
STATIONING ALONG E ROADWAY

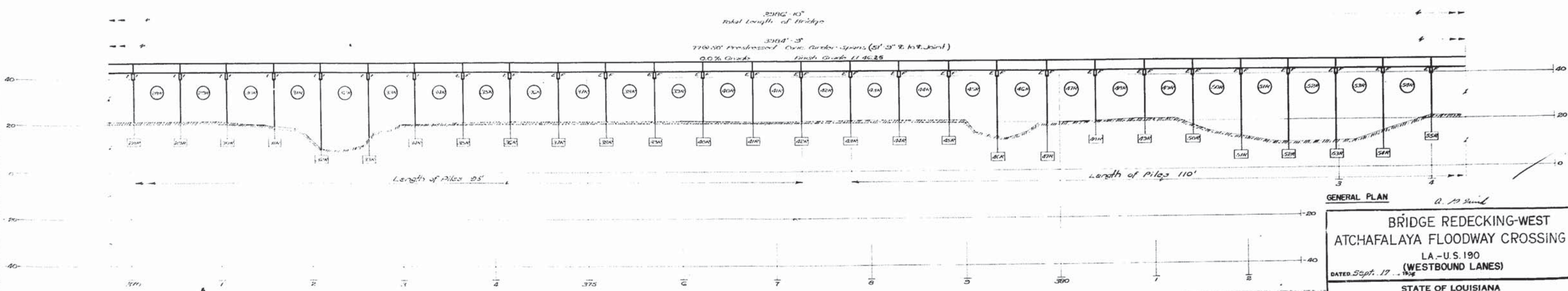

PROFILE OF RIGHT ROADWAY ALONG E ROADWAY  
STATIONING ALONG E ROADWAY  
(IN PLACE TO REMAIN)

GENERAL PLAN  
A. 10-1

BRIDGE REDECKING-WEST  
ATCHAFALAYA FLOODWAY CROSSING  
LA.-U.S. 190  
(WESTBOUND LANES)  
DATED Sept. 17, 1928

STATE OF LOUISIANA DEPARTMENT OF HIGHWAYS		
DESIGNED	DETAILED R. Montegudo	TRACED M. J.
CHECKED	CHECKED P. O.	CHECKED
BRIDGE DESIGN SECTION		

DATE	DESCRIPTION	BY



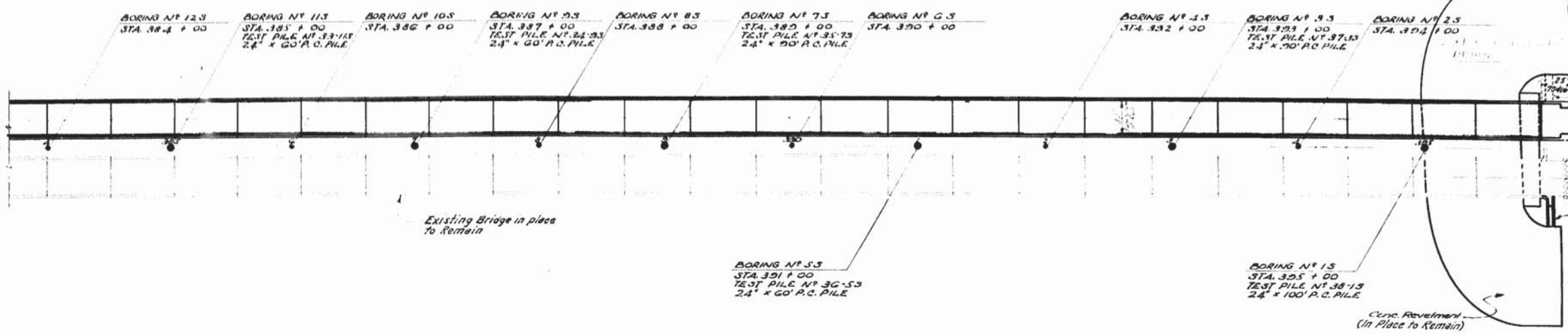

NOTE: Existing Shoulder Drain to be Removed. (No Direct Payment)

125' Item 704(2) 35' 704(3)

Guardrail: e Left Roadway  
e Median  
e Right Roadway

Cure Shoulder Drains

NOTE: Guardrails Reg'd. Lt. Rdwy. East End of Bridge For Guardrail Details not shown See Std. Plans R.F. 20 & G.R. 100.

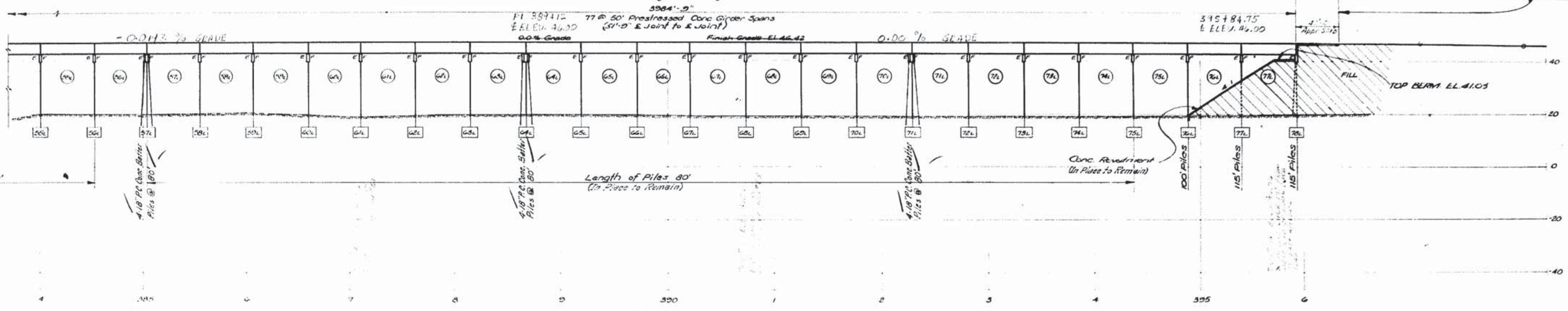

PROFILE OF LEFT ROADWAY ALONG E ROADWAY  
STATIONING ALONG E ROADWAY

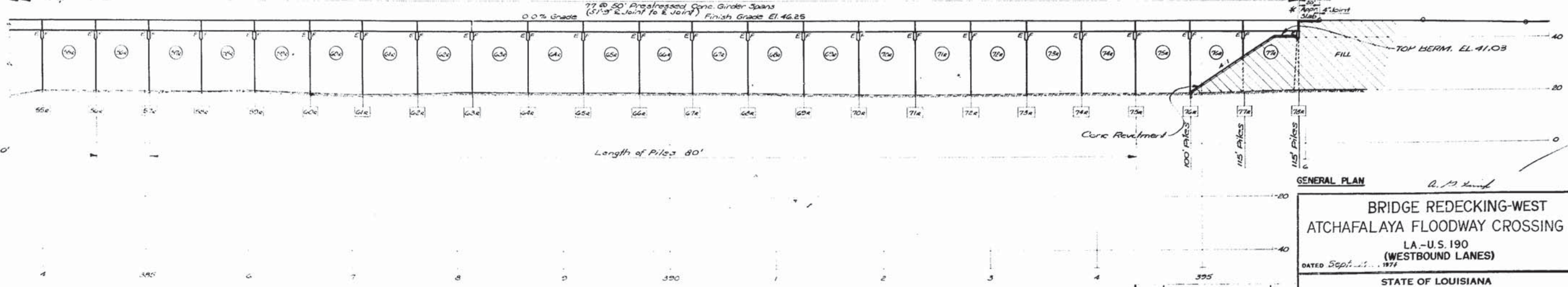

PROFILE OF RIGHT ROADWAY ALONG E ROADWAY  
STATIONING ALONG E ROADWAY  
(IN PLACE TO REMAIN)

GENERAL PLAN

BRIDGE REDECKING-WEST  
ATCHAFALAYA FLOODWAY CROSSING  
LA.-U.S. 190  
(WESTBOUND LANES)  
DATED Sept. 1974

STATE OF LOUISIANA DEPARTMENT OF HIGHWAYS		
DESIGNED	DETAILED R. Montezudo	TRACED Mat
CHECKED	CHECKED P. [Signature]	CHECKED
BRIDGE DESIGN SECTION		

DATE	DESCRIPTION	BY



STATE PROJECT	PARISH	SHEET NO.
8-04-41	ST. LANDRY	7

61

**NOTE**  
 Roadway Surfaces & Shoulders Altered Beyond Ends of the Approach Slabs Due to New Construction shall be Repaired to the Satisfaction of the Project Engineer. No Direct Payment shall be made for this work.  
 All Existing Surfacing, Base Course & Existing Concrete Approach Slab Within the Limits of the Project, including Approach Slabs, End Dam, Angles used for Drainage, and Original End Cams used with the Original Deck that is removed is to be paid for as Item S-102, "Removal of Existing Concrete in Structure" per Lump Sum.

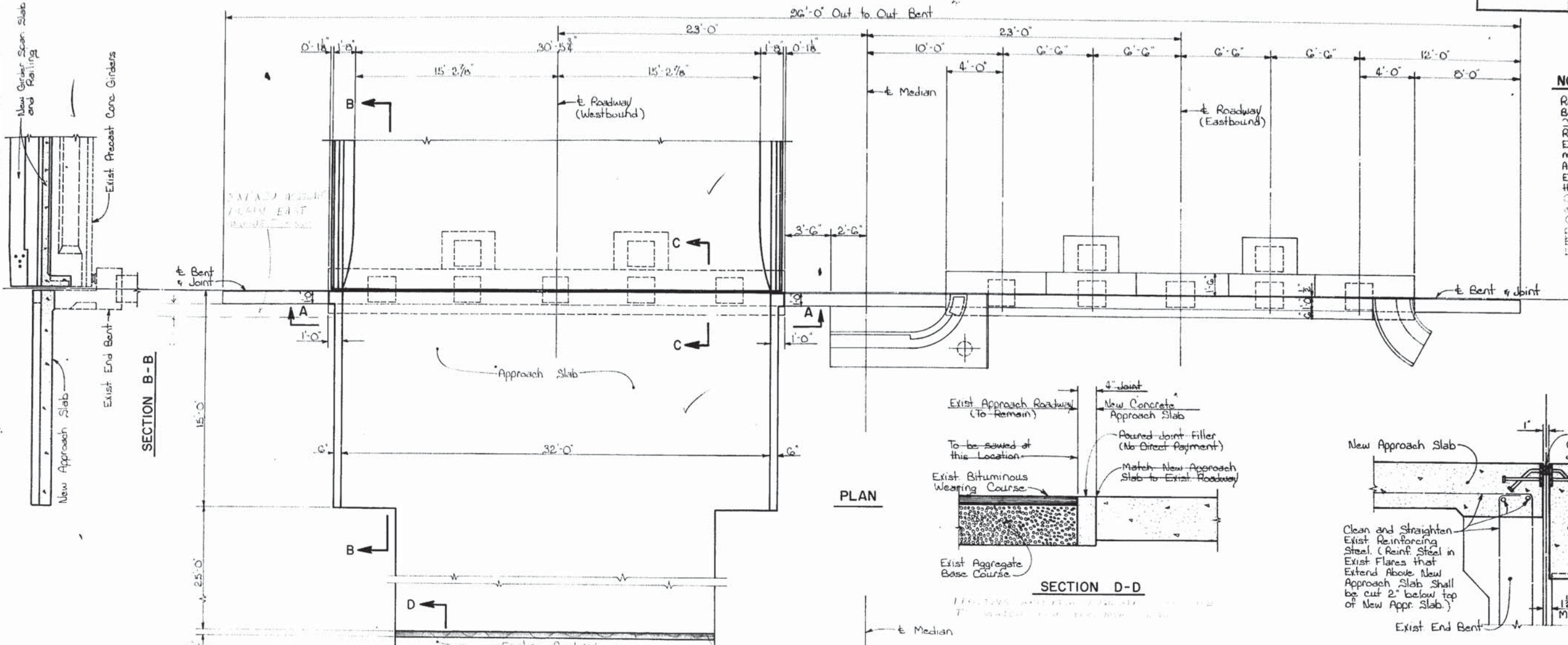

PLAN

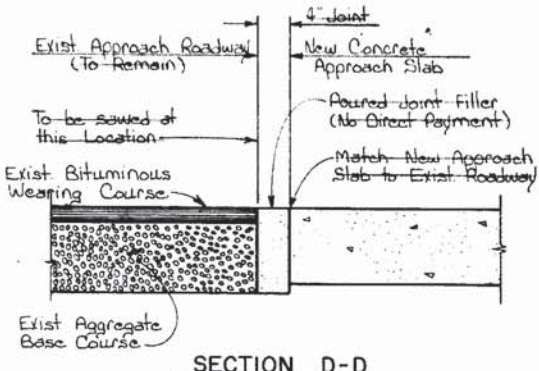

SECTION D-D

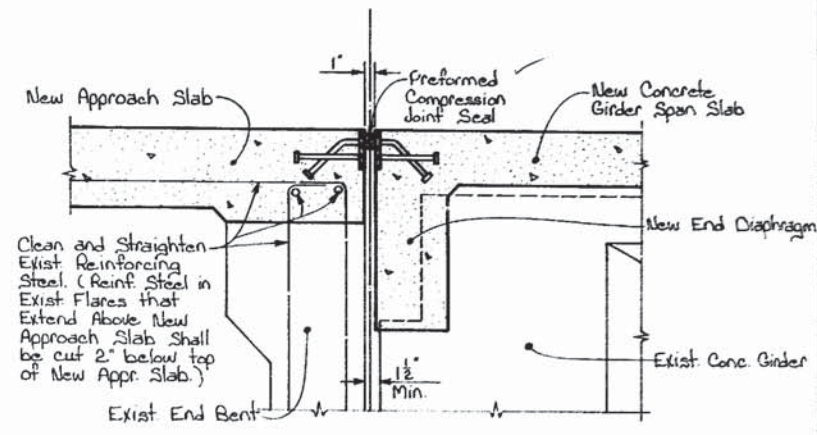

PART SECTION C-C

**NOTE:**  
 For General Notes See Sheet No 2.

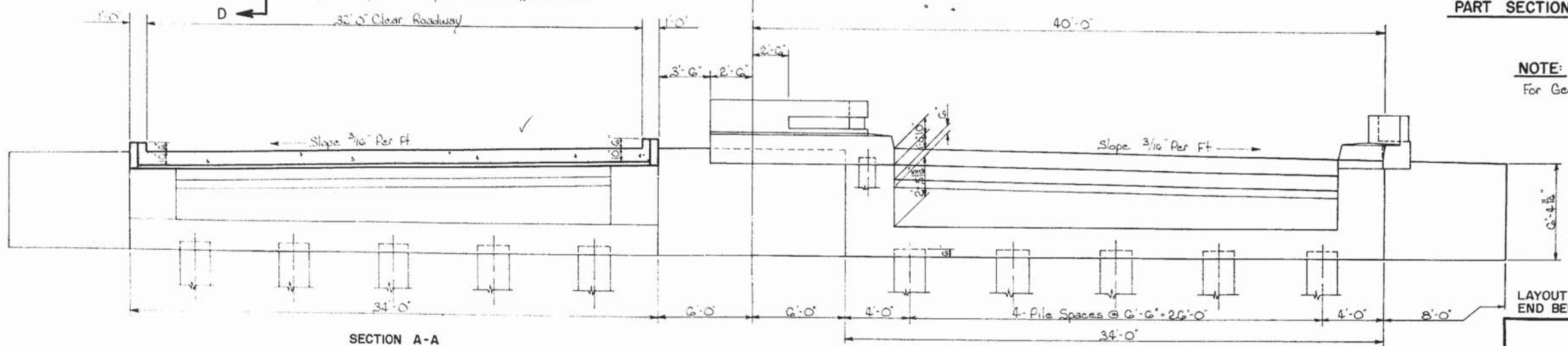

ELEVATION

LAYOUT SHEET AT APPROACH SLABS & END BENTS IL & 78L

**BRIDGE REDECKING - WEST**  
**ATCHAFALAYA FLOODWAY CROSSING**  
 LA-U.S. 190  
 (WESTBOUND LANES)  
 DATED Sept 17, 1974

STATE OF LOUISIANA		
DEPARTMENT OF HIGHWAYS		
DESIGNED	DETAILED C. Dandridge	TRACED Mat
CHECKED	CHECKED J. J. Green	CHECKED
BRIDGE DESIGN SECTION		

DATE	DESCRIPTION	BY



63

ESTIMATED QUANTITIES FOR ONE BENT					
BAR	SIZE	No.	UNIT LENGTH	TOTAL LENGTH	LOCATION
A <sub>1</sub>	#8	16	5'-8"	90'-8"	Long in Cap
A <sub>2</sub>	#8	20	4'-2"	83'-2"	Long in Cap
TOTAL #8 BARS = 174'-0" = 165 LBS.					
S <sub>1</sub>	#4	10	9'-2"	91'-8"	Stirrups in Cap
S <sub>2</sub>	#4	8	6'-3"	50'-0"	Stirrups in Cap
TOTAL #4 BARS = 141'-8" = 95 LBS.					
TOTAL DEFORMED REINF STEEL = 560 LBS.					
CLASS 'A' CONCRETE IN BENT = 3.22 CU YDS					
Φ 3/4" x 10" STUD-ANCHOR BOLTS = 24 EACH					

Φ No direct payment.

NOTE:  
For General Notes see Sheet No 2.  
All Corners to be Chamfered 1 1/2".

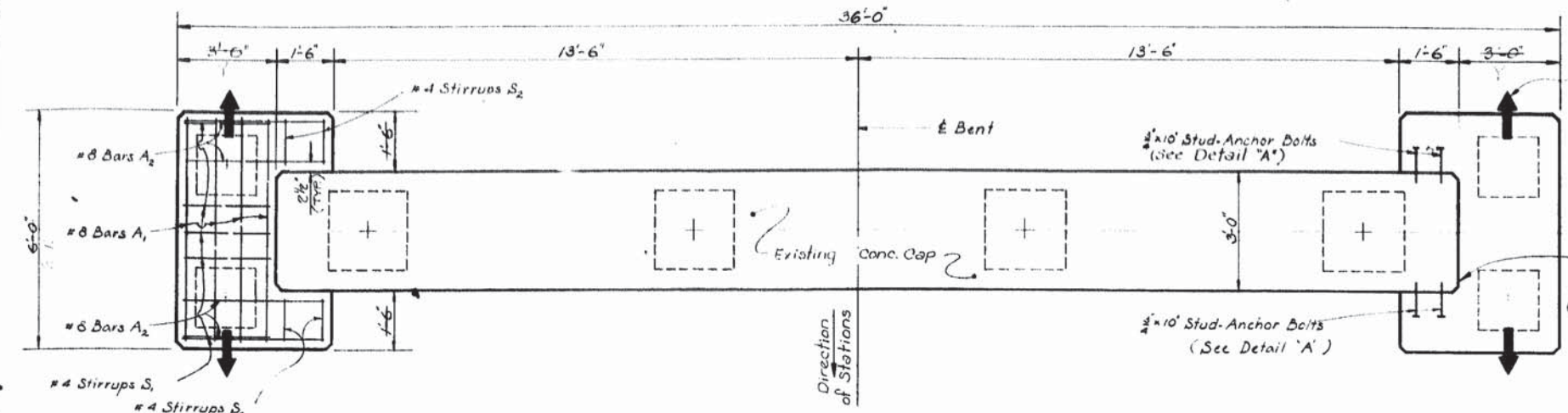

HALF PLAN SHOWING REINF. STEEL

HALF PLAN SHOWING STUD-ANCHOR BOLTS

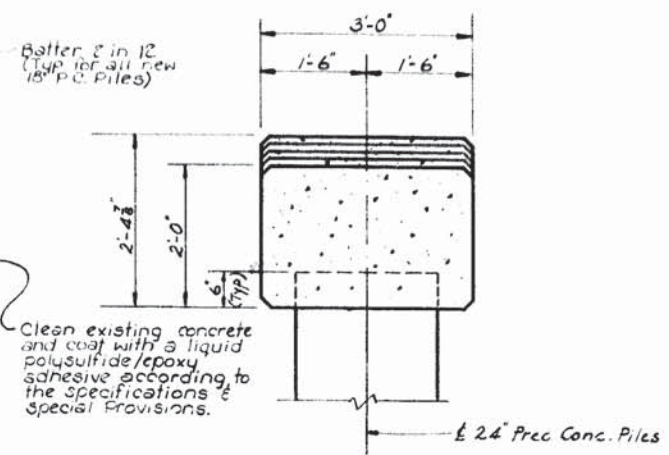

SECTION A-A

(EXISTING BENT; STEEL NOT SHOWN)

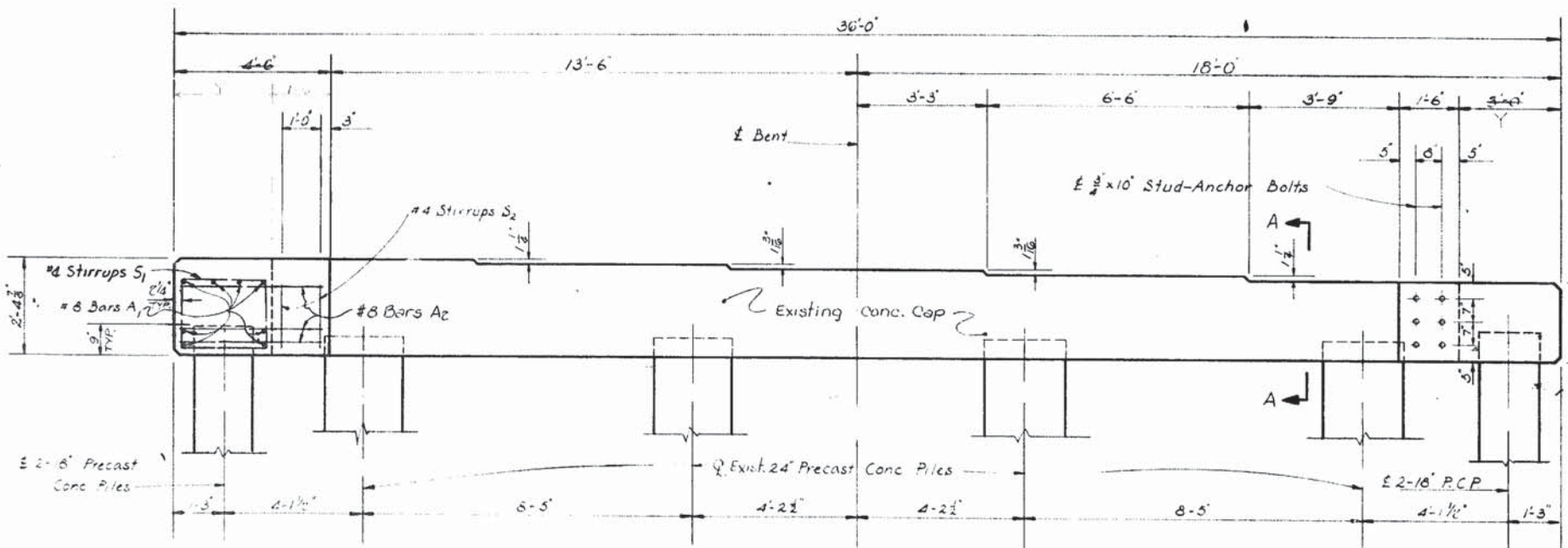

HALF ELEVATION (LOOKING DOWN STATION)

HALF ELEVATION (LOOKING DOWN STATION)

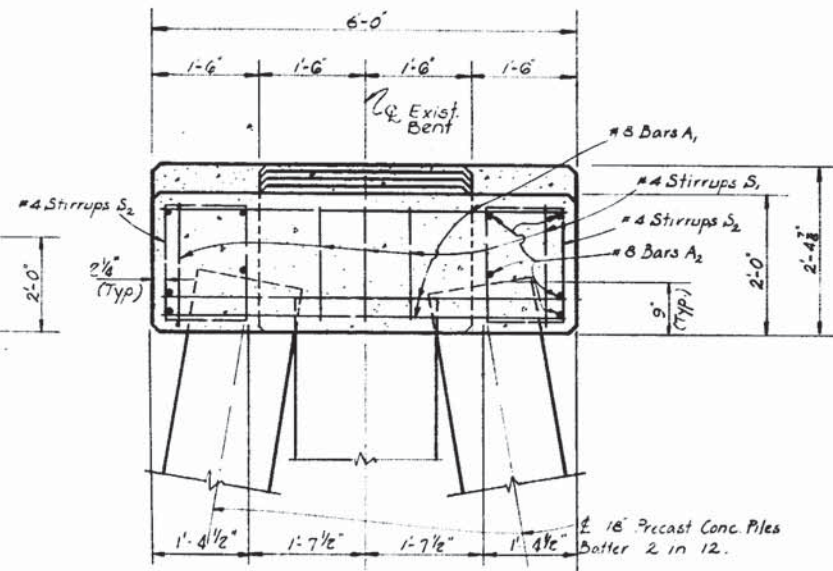

END ELEVATION

(STUD-ANCHOR BOLTS NOT SHOWN)

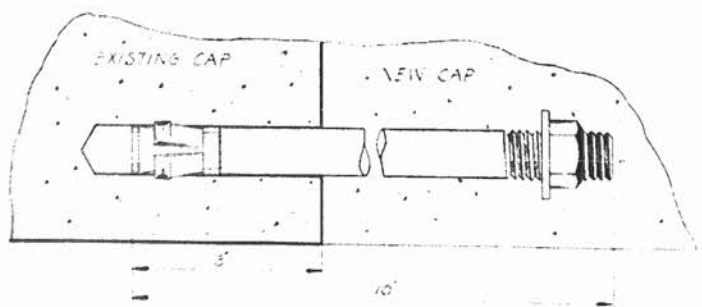

DETAIL A

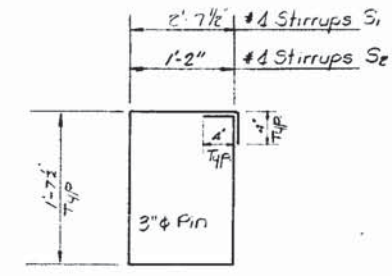

#4 STIRRUPS S<sub>1</sub> & S<sub>2</sub>

MODIFICATIONS TO EXISTING BENTS NO 8L, 15L, 22L, 29L, 36L, 43L, 50L, 57L, 64L & 71L

BRIDGE REDECKING-WEST ATCHAFALAYA FLOODWAY CROSSING LA-US 190 (WESTBOUND LANES) DATED Sept. 17, 1970			
STATE OF LOUISIANA DEPARTMENT OF HIGHWAYS			
DESIGNED	V.C.	DETAILED	V.C.
CHECKED	P.M.	CHECKED	P.C.
DATE		BY	
REVISIONS			
TRACED		MOT	
BRIDGE DESIGN SECTION			



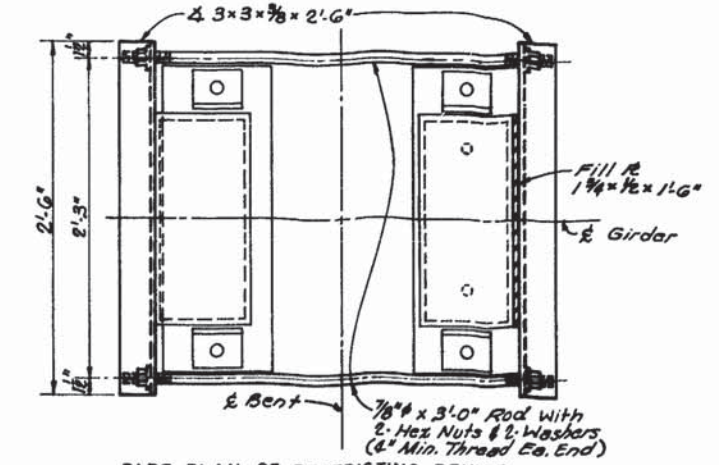
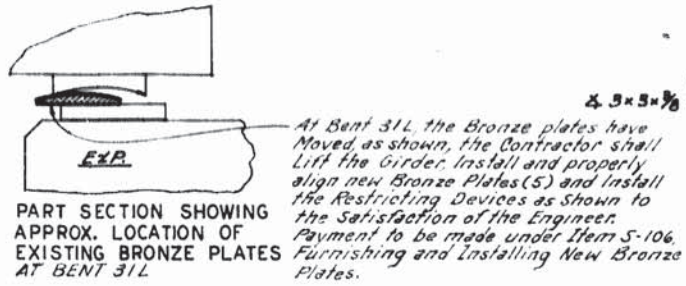
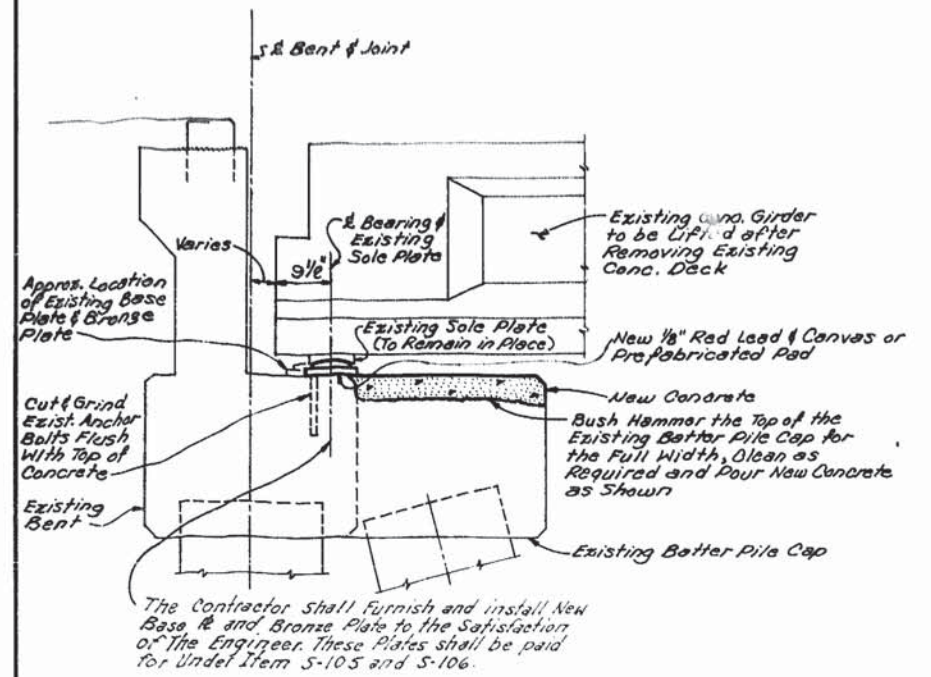

**RESTRICTING DEVICES FOR EXISTING BEARING SHOES - INTERMEDIATE BENTS**  
 NOTE: Restricting Devices Will be Paid for Under Item S-103, per Each. Approx. 191 New Restricting Devices will be Required. All Steel used for Restricting Devices is to be Structural Carbon Steel A-36.

BENT	Nº REQ'D	LOCATION	REMARKS
3L	5	10 Ea. Girder	
6L	5	10 Ea. Girder	
10L	2	10 Ea. Ext. Girder	
11L	5	10 Ea. Girder	
12L	5	10 Ea. Girder	
13L	2	10 Ea. Ext. Girder	
14L	5	10 Ea. Girder	
16L	5	10 Ea. Girder	
20L	5	10 Ea. Girder	
22L	5	10 Ea. Girder	
25L	2	10 Ea. Ext. Girder	
26L	5	10 Ea. Girder	
29L	5	10 Ea. Girder	
31L	5	10 Ea. Girder	New Bronze to be Installed & Realigned
33L	5	10 Ea. Girder	
34L	5	10 Ea. Girder	
35L	2	10 Ea. Ext. Girder	
37L	5	10 Ea. Girder	
39L	2	10 Ea. Ext. Girder	
41L	5	10 Ea. Girder	
42L	5	10 Ea. Girder	
43L	2	10 Ea. Ext. Girder	
45L	5	10 Ea. Girder	
46L	5	10 Ea. Girder	
47L	2	10 Ea. Ext. Girder	
48L	2	10 Ea. Ext. Girder	
50L	5	10 Ea. Girder	
51L	5	10 Ea. Girder	
52L	2	10 Ea. Ext. Girder	
55L	5	10 Ea. Girder	
56L	2	10 Ea. Ext. Girder	
57L	5	10 Ea. Girder	
58L	5	10 Ea. Girder	
59L	5	10 Ea. Girder	
60L	2	10 Ea. Ext. Girder	
61L	5	10 Ea. Girder	
62L	5	10 Ea. Girder	
63L	2	10 Ea. Ext. Girder	
64L	5	10 Ea. Girder	
65L	5	10 Ea. Girder	
66L	2	10 Ea. Ext. Girder	
67L	2	10 Ea. Ext. Girder	
68L	5	10 Ea. Girder	
70L	2	10 Ea. Ext. Girder	
71L	5	10 Ea. Girder	
73L	5	10 Ea. Girder	
74L	2	10 Ea. Ext. Girder	
75L	2	10 Ea. Ext. Girder	
76L	2	10 Ea. Ext. Girder	

**MODIFICATIONS FOR BEARING SHOES - BENT Nº 1L**  
 NOTE: All Modifications to End Bent 1L, except for Furnishing and Installing Base Plates and Bronze Plates, to be paid for Under Item S-107, Modification to End Bent 1L, per lump sum.

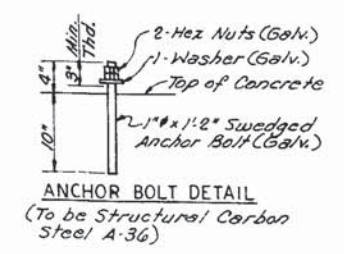
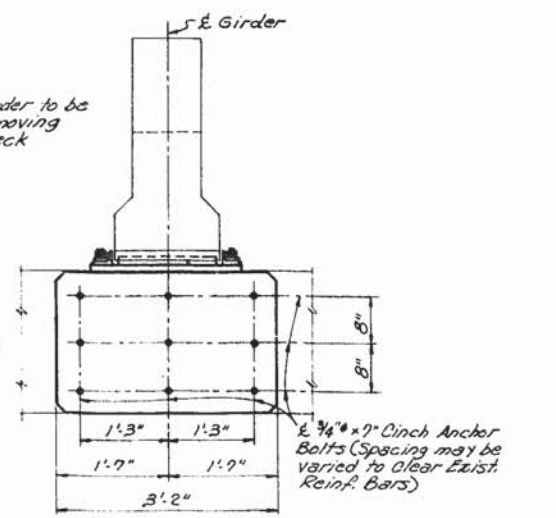
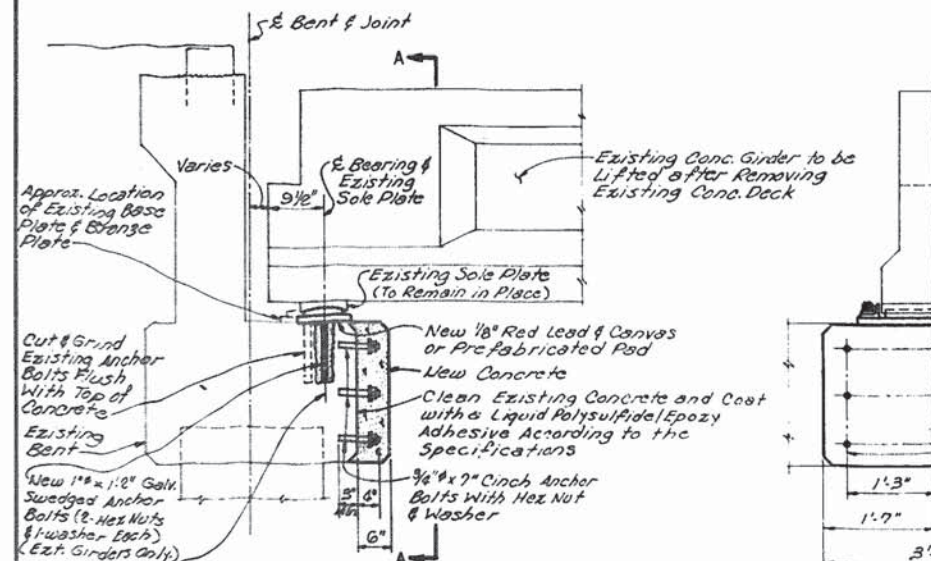

**MODIFICATIONS FOR BEARING SHOES - BENT Nº 1L EXTERIOR GIRDERS**

NOTE: For "GENERAL NOTES" See Sheet Nº 2

MODIFICATIONS TO EXISTING BEARING SHOES

**BRIDGE REDECKING - WEST**  
**ATCHAFALAYA FLOODWAY CROSSING**  
 LA.-U.S. 190  
 (WESTBOUND LANES)  
 DATED Sept. 17, 1976

STATE OF LOUISIANA  
 DEPARTMENT OF HIGHWAYS

DESIGNED	DETAILED	TRACED
CHECKED	CHECKED	CHECKED

BRIDGE DESIGN SECTION

DATE	DESCRIPTION	BY



65

**NOTE "D":**  
The R/W Dimension Required by the Plans is to be maintained at all locations and is to be defined as required within the Span in order to maintain a constant clear roadway and to maintain the Deck to the proper Grade.

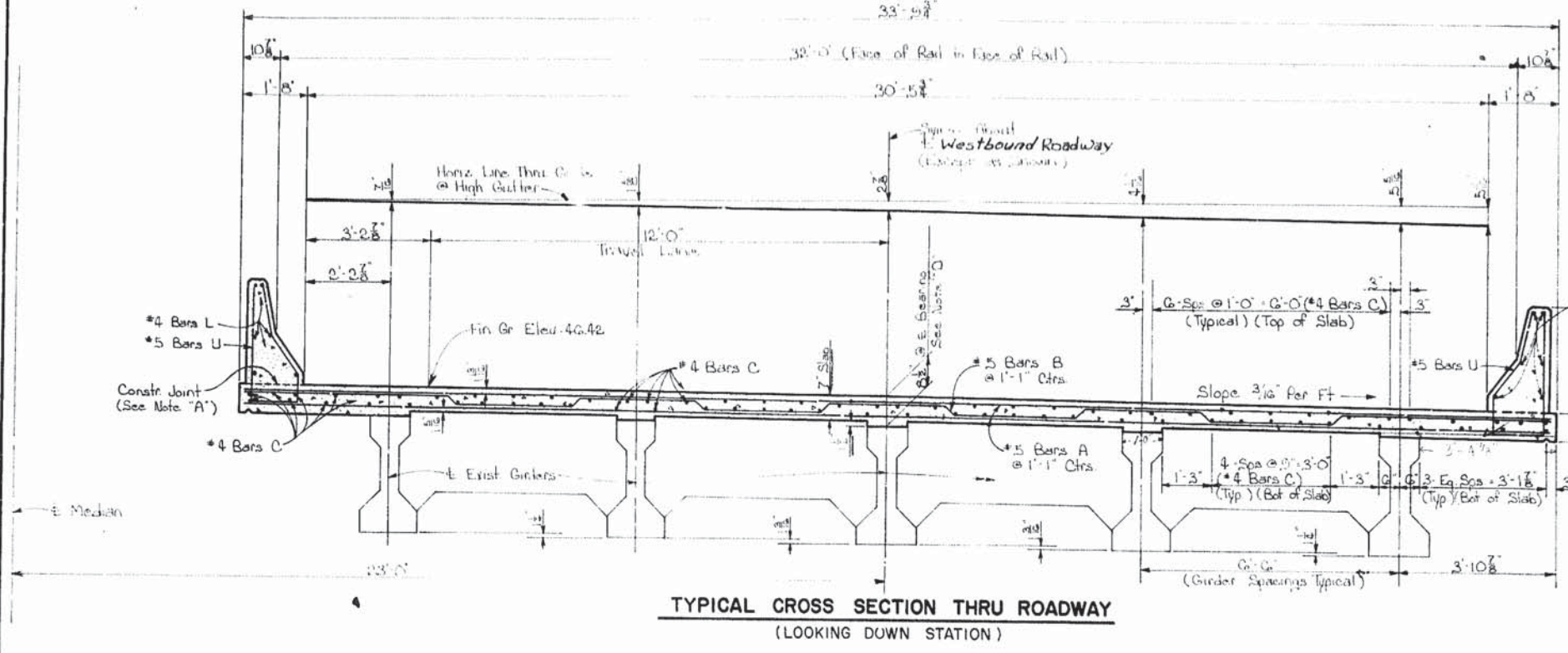

**TYPICAL CROSS SECTION THRU ROADWAY**  
(LOOKING DOWN STATION)

**NOTE:**  
EXISTING DECK, SAFETY CURB, RAILING & END DIAPHRAGMS TO BE REMOVED.

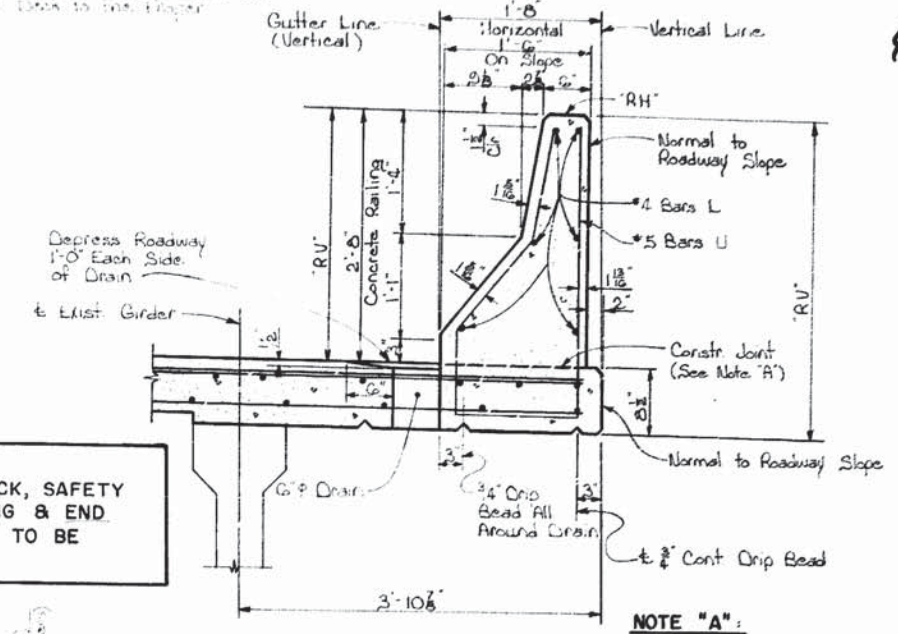

**PART SECTION C-C**

**NOTE "A":**  
After Completing Pour for Roadway Slab, a min. of 2-0\"/>

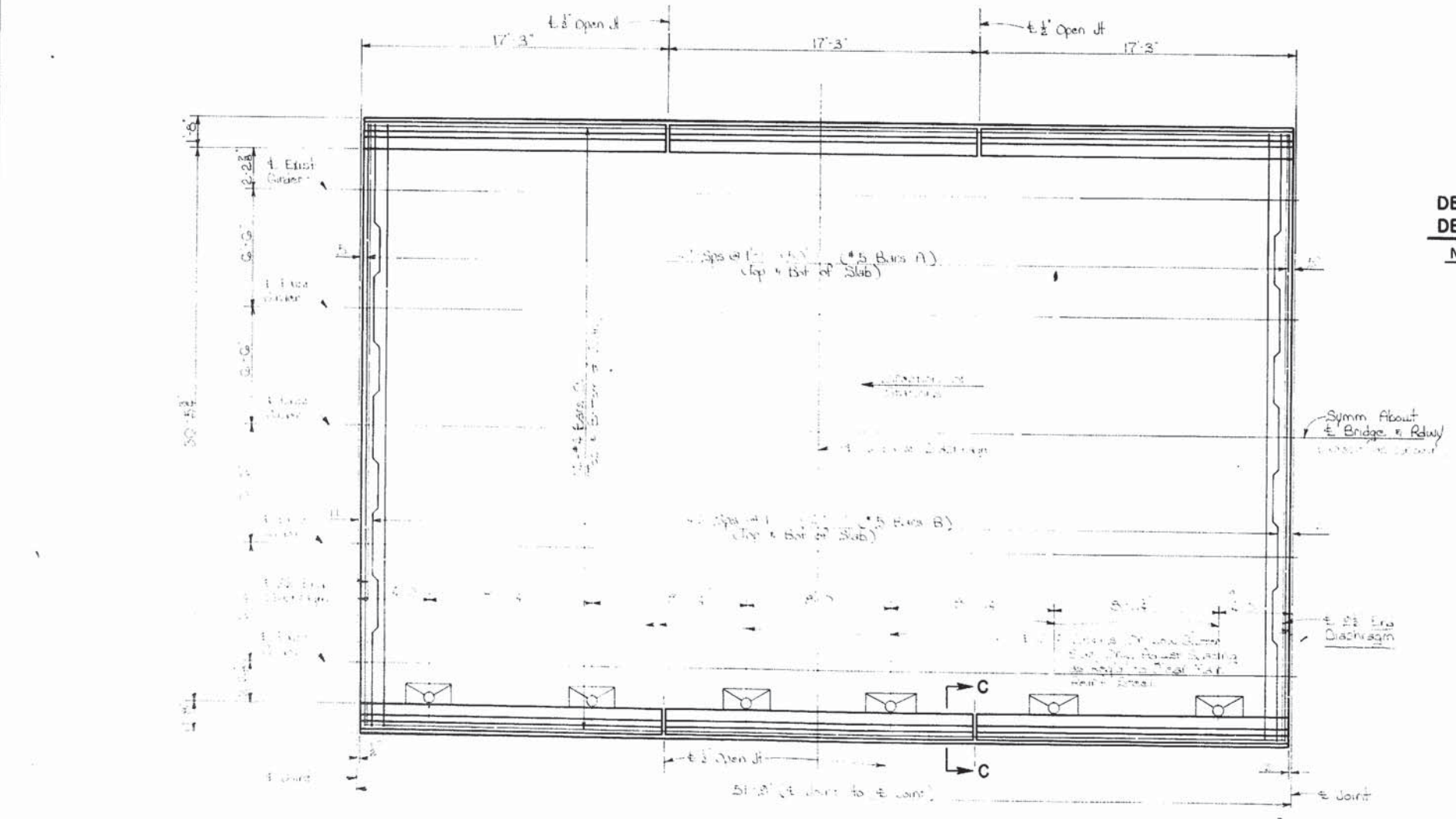

**PLAN**

Approximate Position of Top Flange of Girder Under Prestress Force and Dead Load of Girder After Removal of Exh. Conc. Deck.

Approximate Position of Top Flange of Girder Under Total Dead Load of New Conc. Deck.

**DEFLECTION OF EXISTING CONCRETE GIRDER UNDER DEAD LOAD OF NEW CAST-IN-PLACE CONCRETE DECK**

**NOTE:** The Girder deflection measured and verified in the field after Removal of Existing Concrete Deck in order to properly form the New Deck and Maintain a constant slab thickness.

DEAD LOAD REACTION	EXT. GIRDERS	INT. GIRDERS
	36.70 <sup>k</sup>	29.8 <sup>k</sup>

\* INCLUDES 19<sup>#</sup>/sq ft. WEARING SURFACE.

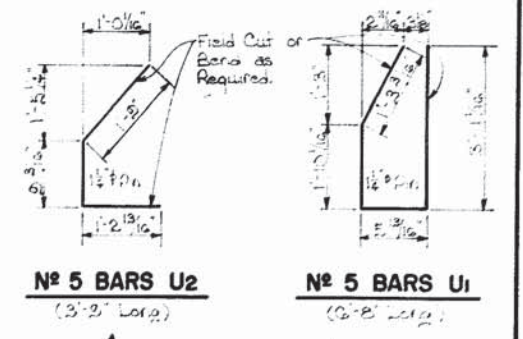

**#5 BARS U2** (3'-3\"/>

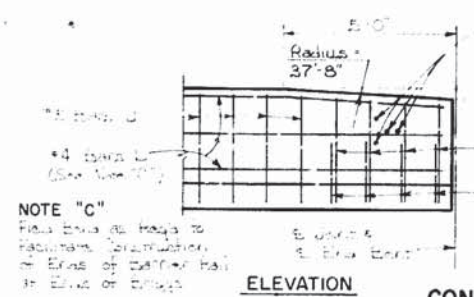

**NOTE "C":**  
Flas Bars as Keys to Reinforce Construction of Ends of Diaphragm at Ends of Bridge.

**ELEVATION**

**CONCRETE RAILING DETAILS AT BRIDGE ENDS**

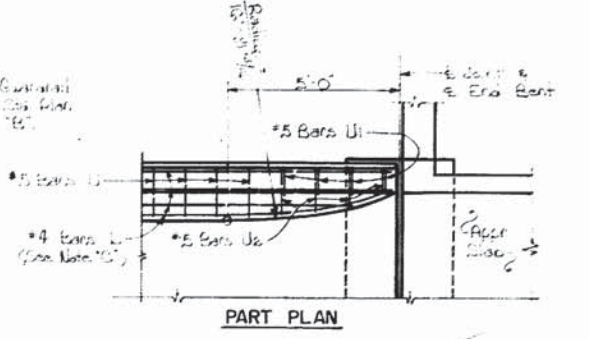

**PART PLAN**

**NOTE "B":**  
Provide eight Holes on All Four (4) Corners of Bridge. See the Plan 3'-0\"/>

**BRIDGE REDECKING - WEST**  
**ATCHAFALAYA FLOODWAY CROSSING**  
LA-U.S. 190  
(WESTBOUND LANES)  
DATED Sept. 17, 1976

STATE OF LOUISIANA DEPARTMENT OF HIGHWAYS		
DESIGNED <i>Bar</i>	DETAILED <i>C. Darden</i>	TRACED <i>Mot</i>
CHECKED <i>D. Williams</i>	CHECKED <i>P. B. ...</i>	CHECKED
BRIDGE DESIGN SECTION		

DATE	DESCRIPTION	BY
	REVISIONS	



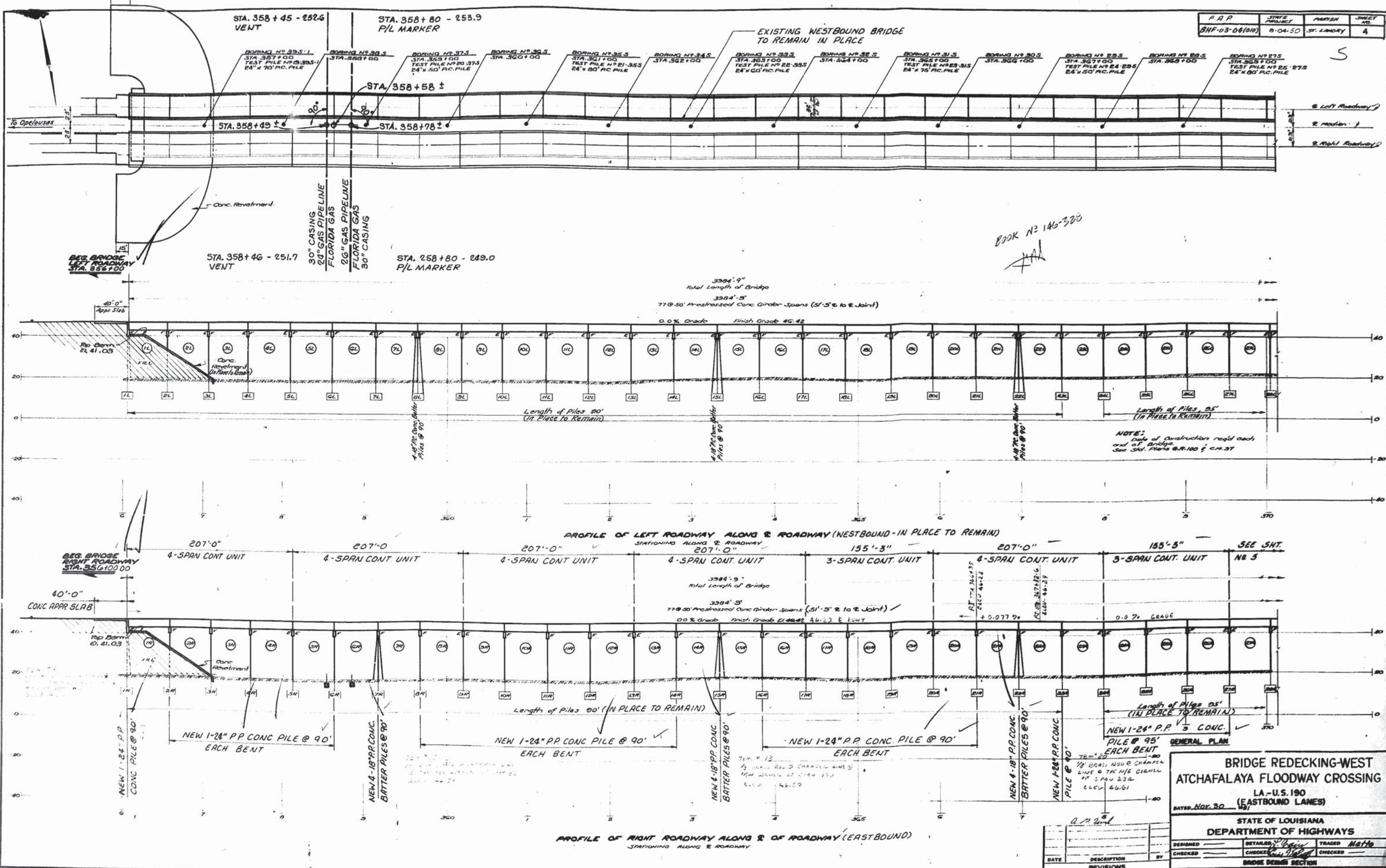

As BUILTS



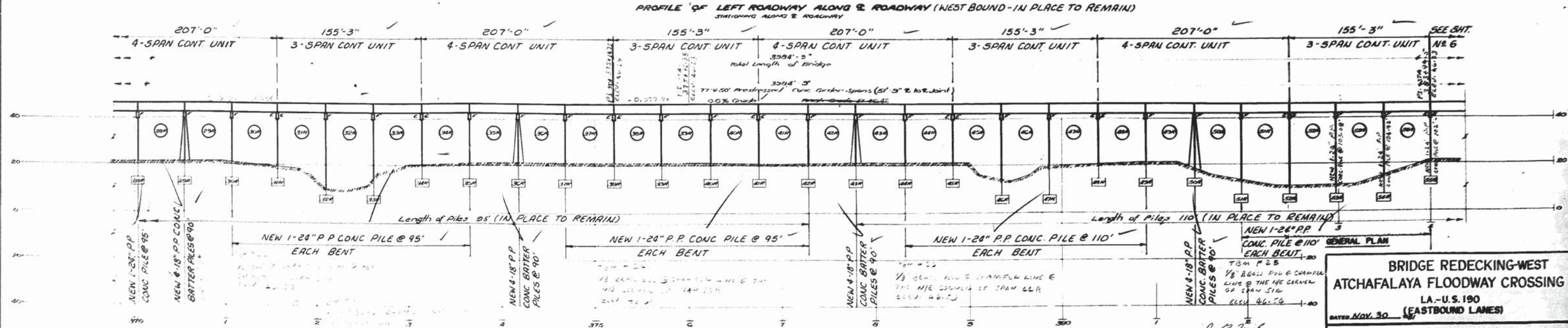
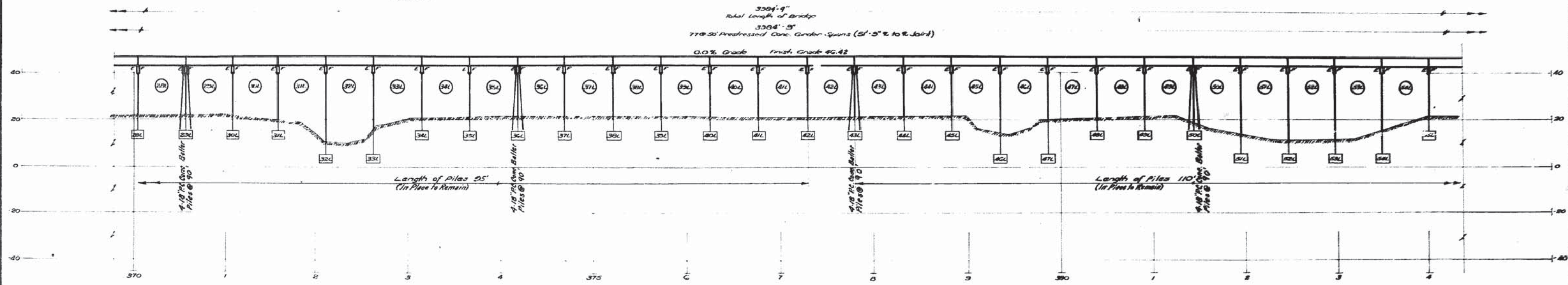
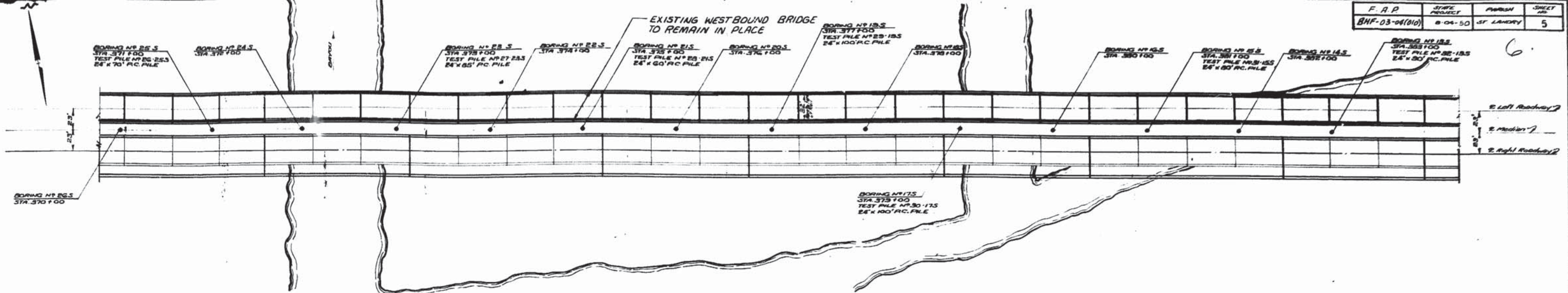

**BRIDGE REDECKING-WEST**  
**ATCHAFALAYA FLOODWAY CROSSING**  
 LA.-U.S. 190  
 (EASTBOUND LANES)  
 DATED NOV. 30

STATE OF LOUISIANA  
 DEPARTMENT OF HIGHWAYS

DESIGNED	REVIEWED	TRACED
CHECKED	CHECKED	CHECKED

BRIDGE DESIGN SECTION

DATE	DESCRIPTION	BY

As BUILTS



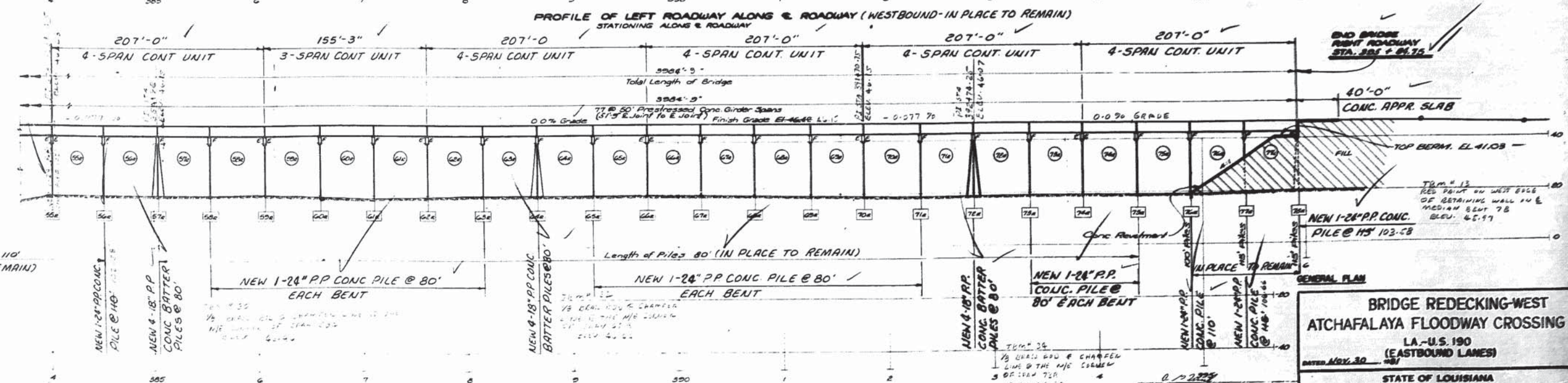
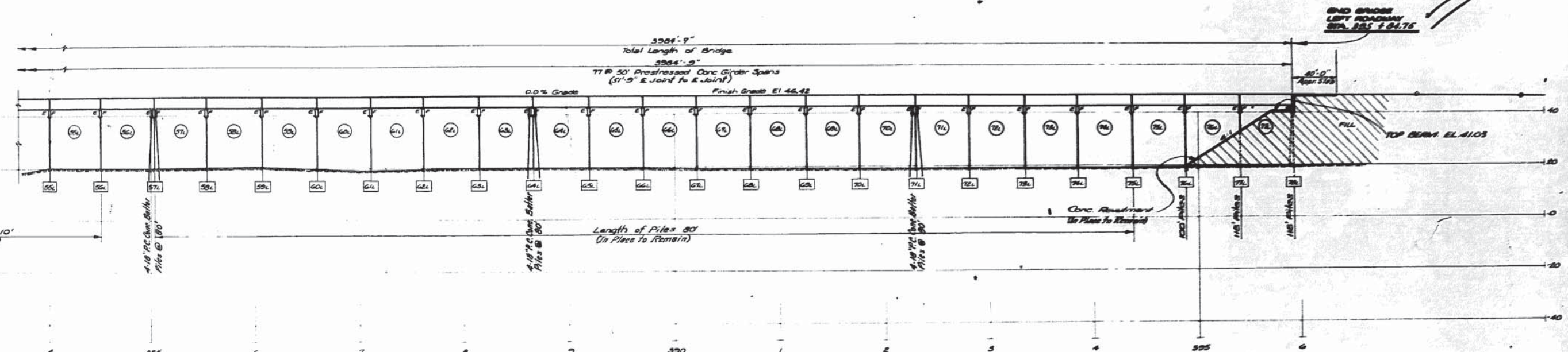
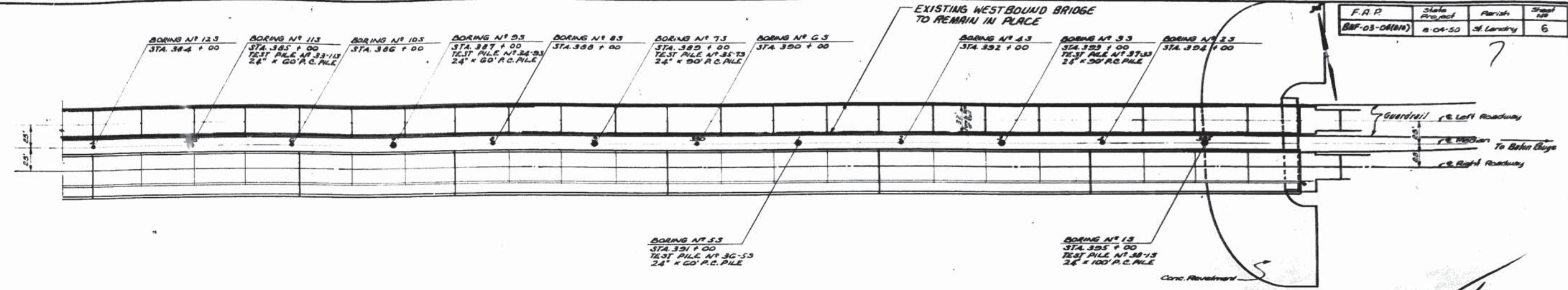

**BRIDGE REDECKING-WEST**  
**ATCHAFALAYA FLOODWAY CROSSING**  
 LA.-U.S. 190  
 (EASTBOUND LANES)  
 DATED MAY 30 1951

STATE OF LOUISIANA  
 DEPARTMENT OF HIGHWAYS

DESIGNED	BY	TRAFFIC	DATE
CHECKED	BY	CHECKED	DATE

BRIDGE DESIGN SECTION

As BUILTS



F.A.P.	STATE PROJECT	PROJECT	CONTRACT NO.
MP-05-04(10)	S-04-50	ST. LAWRY	17

ESTIMATED QUANTITIES (ONE SLAB) 18

BAR NO.	BAR SIZE	UNIT LENGTH	TOTAL LENGTH	LOCATION
607	#4	185'-0"	185'-0"	LENGTH BOT. OF SLAB
608	#4	24'-0"	24'-0"	" " " "
609	#4	20'-0"	20'-0"	" " " "
TOTAL REBAR (BOT. OF SLAB)			229'-0"	
610	#4	24'-0"	24'-0"	LENGTH TOP OF SLAB
611	#4	20'-0"	20'-0"	" " " "
612	#4	24'-0"	24'-0"	LENGTH BOT. OF SLAB
613	#4	20'-0"	20'-0"	" " " "
TOTAL REBAR (TOP OF SLAB)			208'-0"	
TOTAL REBAR (BOT. & TOP OF SLAB)			437'-0"	
TOTAL REBAR (CONCRETE APPROACH SLAB)			437'-0"	
TOTAL REBAR (STRUCTURAL STEEL SLAB)			247'-0"	

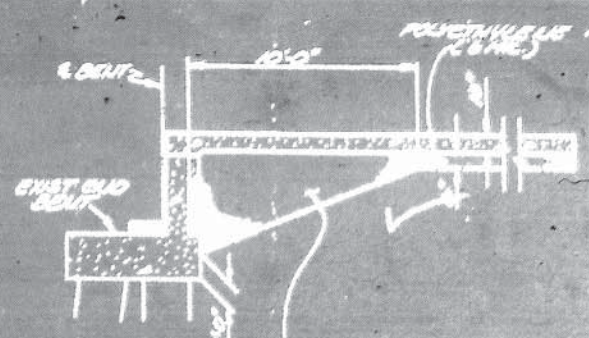

AGGREGATE BACKFILL (PLAIN SHELL OR WASHED SAND) LIMITS TO BE THE OUTER EDGES OF THE APPROACH SLAB. POLYETHYLENE MEMBRANE (1/2" THICKNESS) TO BE INSTALLED BETWEEN THE AGGREGATE BACKFILL AND THE CONC. APPROX. SLAB FOR THE ENTIRE LENGTH OF AGGREGATE BACKFILL. AGGREGATE BACKFILL TO BE UNIFORMLY COMPACTED AS DIRECTED BY THE PROJECT ENGINEER. AGGREGATE BACKFILL POLYETHYLENE MEMBRANE TO BE INCLUDED IN PRICE BID FOR "CONC. APPROX. SLAB" PER SQ. YD.

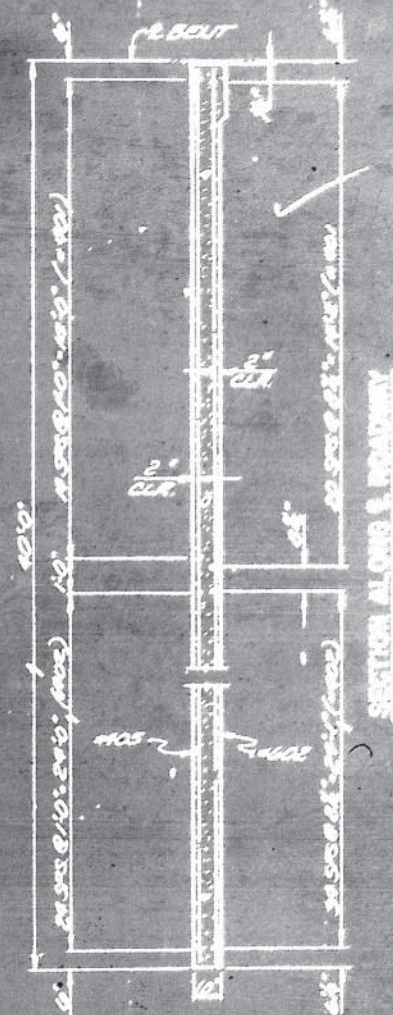
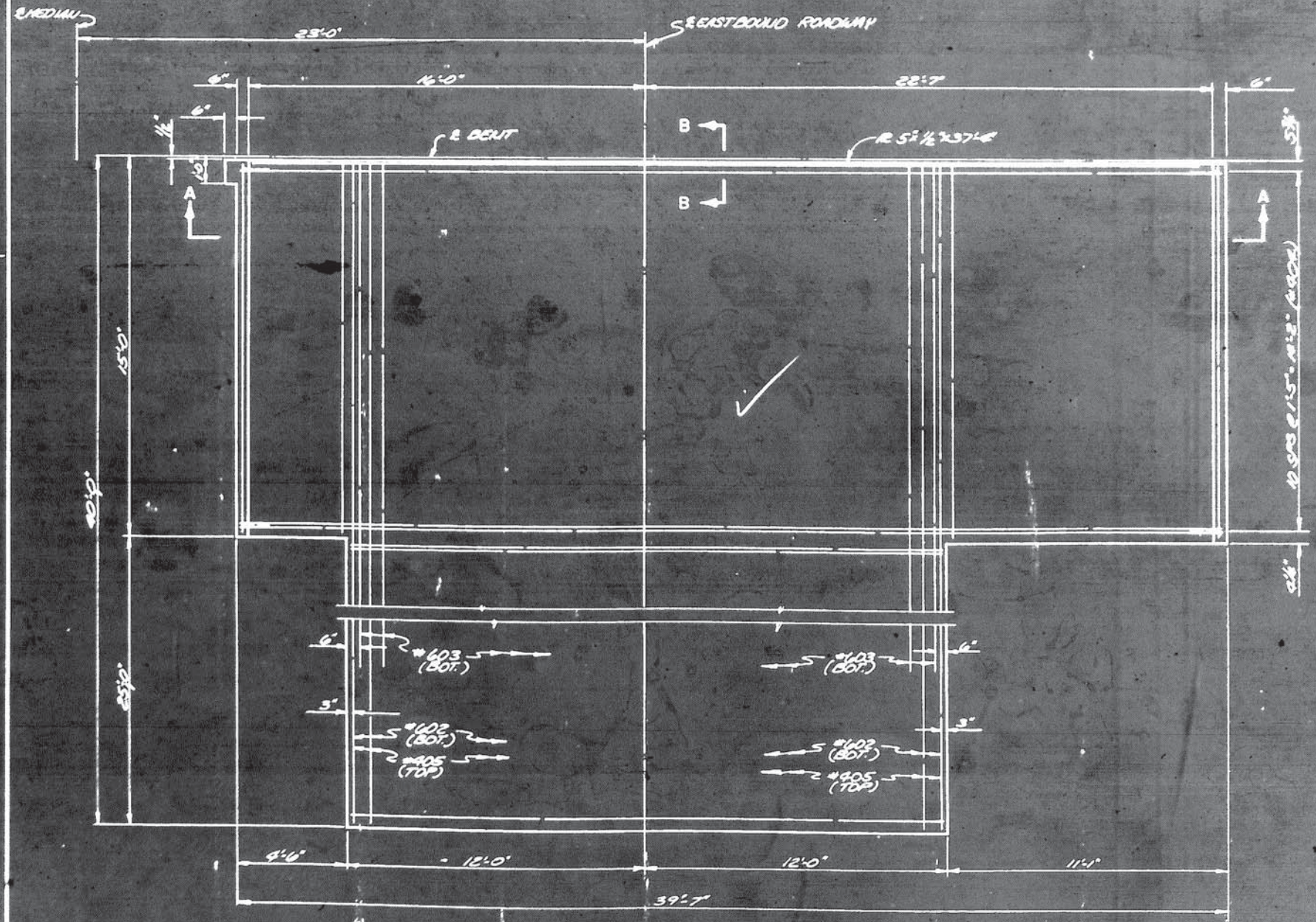
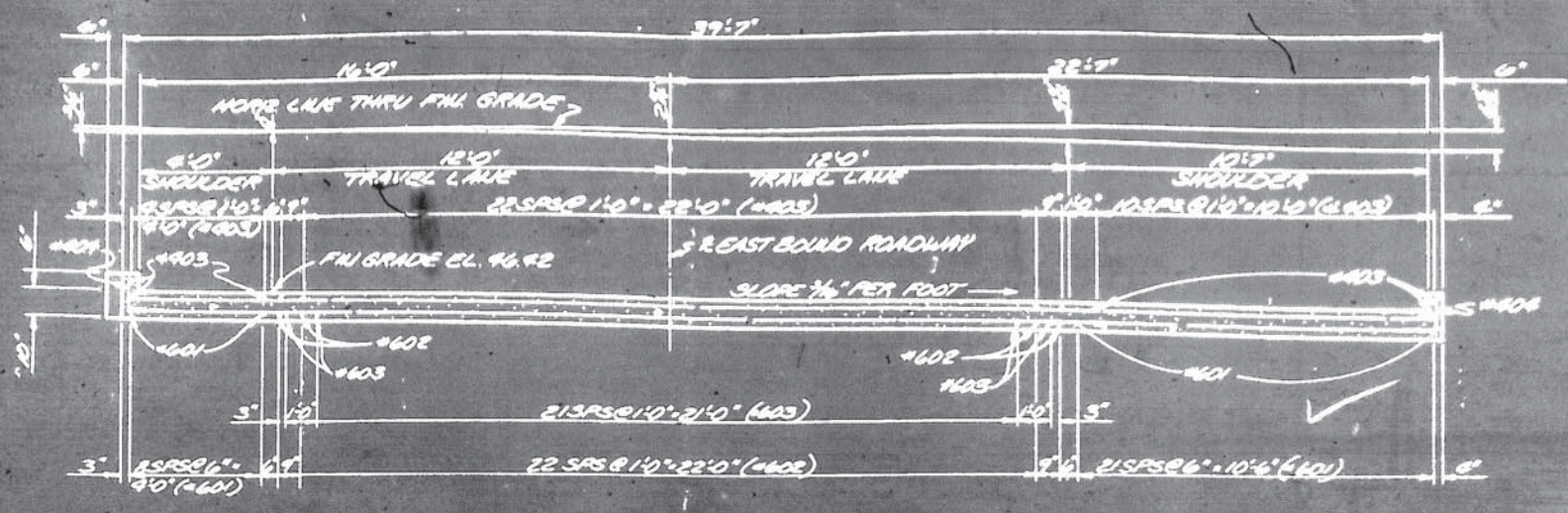

NOTE: ALL DIMENSIONS TO BE CHECKED IN FIELD. ALL DIMENSIONS TO BE CHECKED IN FIELD.

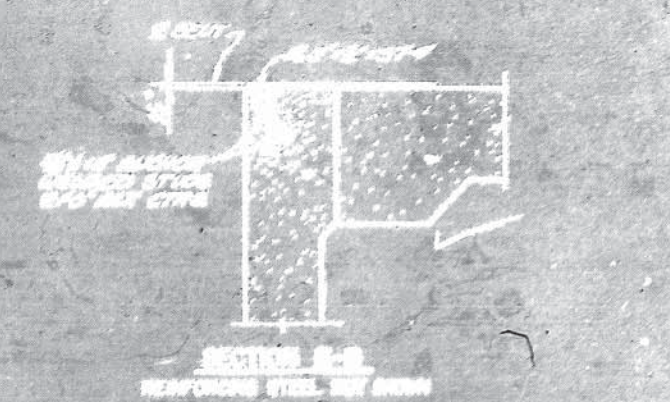

APPROACH SLAB, S. ROADWAY

ENGINE: PETERSON-TRACY  
 ARCHITECT: J.L. GIBSON ENGINEERS  
 S.F. 48000  
 CIVIL ENGINEERS

AS BUILTS







E.A.P.	DATE	PROJECT	NO.
BW-05-04(04)	8-04-60	ST. LANDRY	25

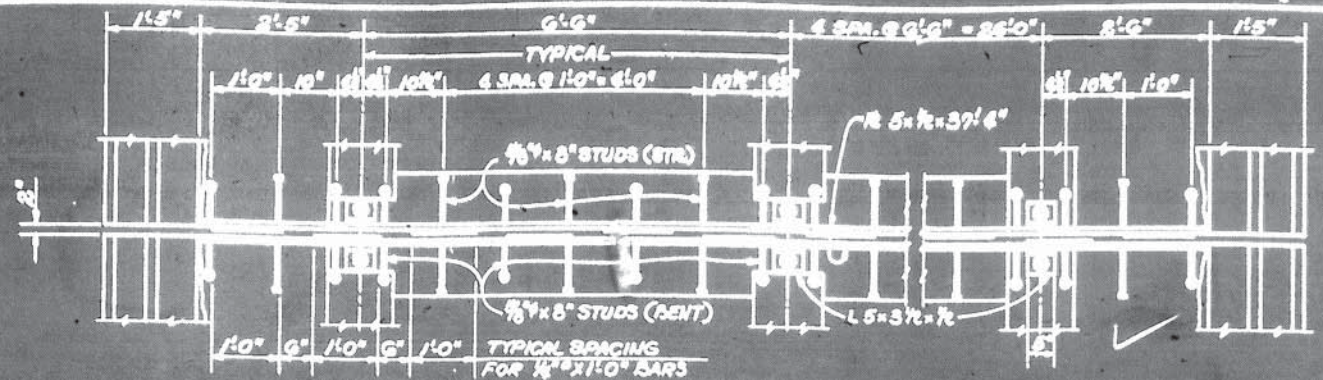

**PART PLAN OF EXPANSION JOINT END DAMS**  
(CONCRETE DECK & COMPRESSION SEAL NOT SHOWN)

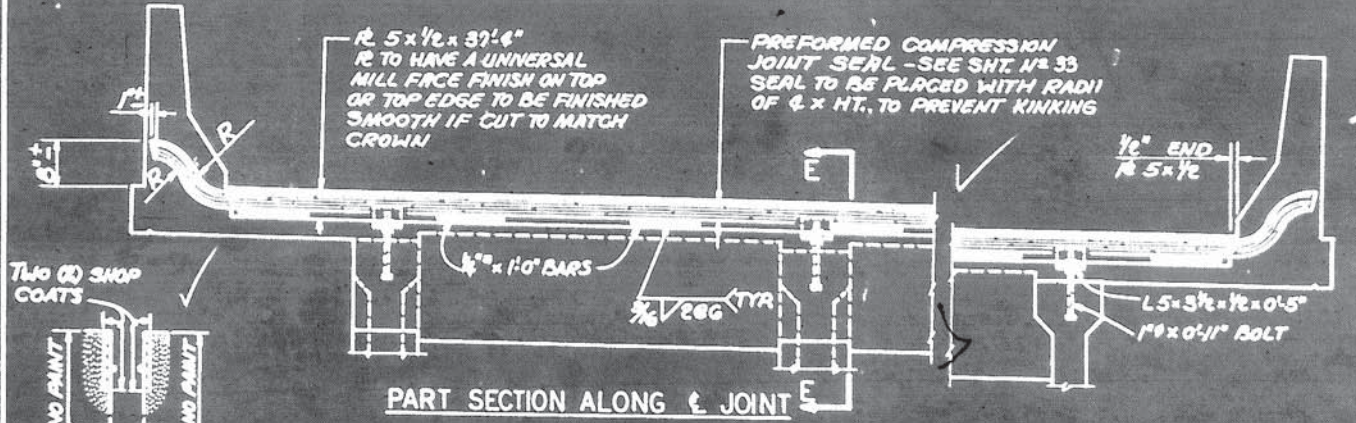

**PART SECTION ALONG E JOINT**

**END DAM PAINT REQUIREMENTS**

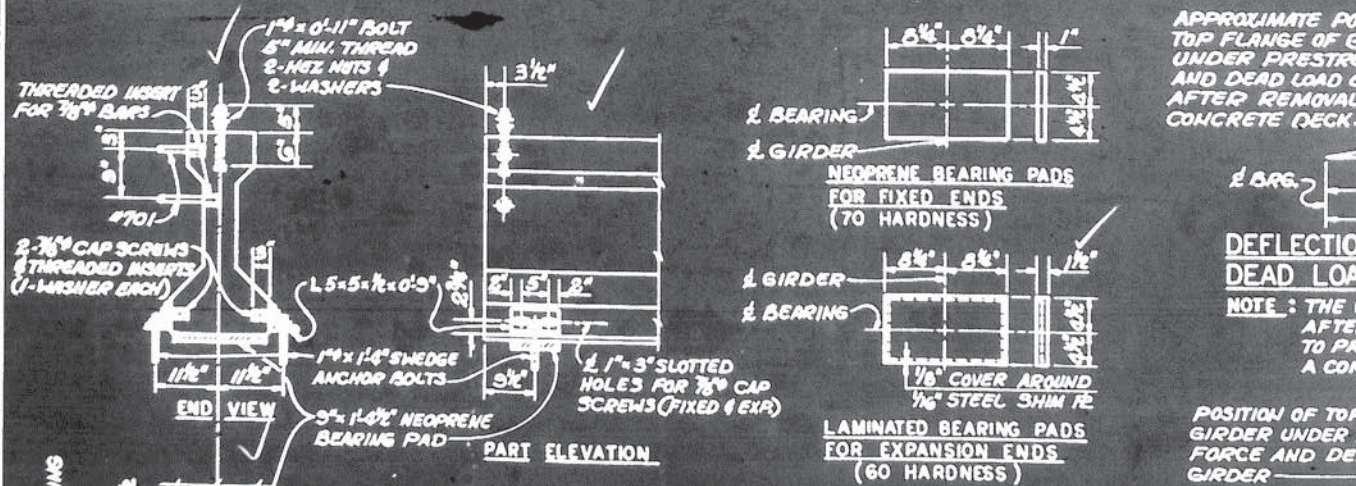

**NEW CONCRETE GIRDER BEARING DETAILS**

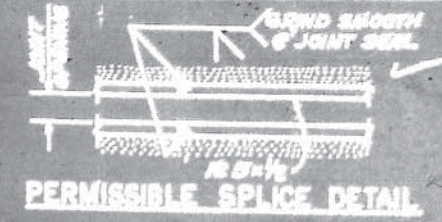

**PERMISSIBLE SPLICE DETAIL**



**ALTERNATE STRAP ANCHORS**

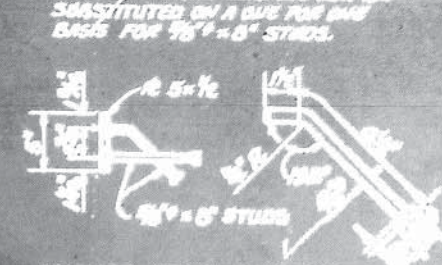

**ANCHOR STUD DETAILS**

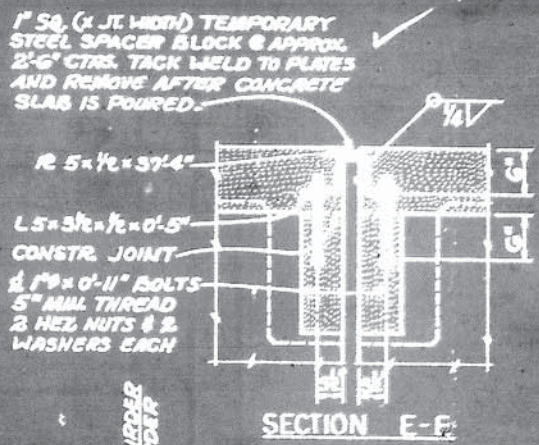

**SECTION E-F**

**DEFLECTION OF EXISTING CONCRETE GIRDER UNDER DEAD LOAD OF NEW CAST-IN-PLACE CONCRETE DECK**  
NOTE: THE CAMBER SHALL BE MEASURED AND VERIFIED IN THE FIELD AFTER REMOVAL OF THE EXISTING CONCRETE DECK IN ORDER TO PROPERLY FORM THE NEW CONCRETE DECK AND MAINTAIN A CONSTANT SLAB THICKNESS.

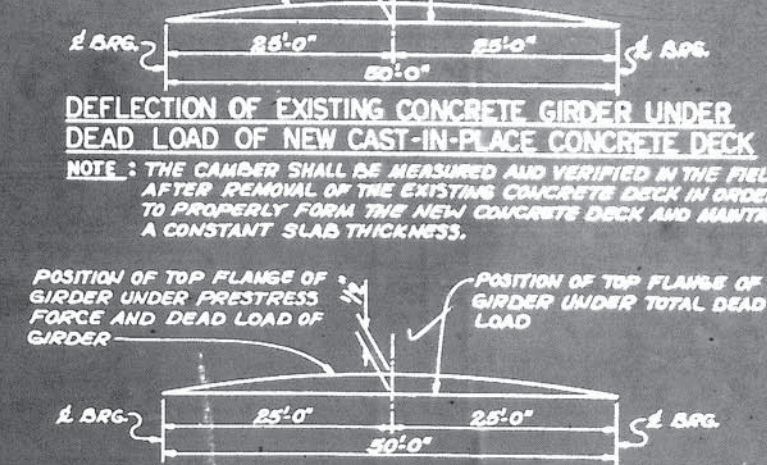

**DEFLECTION OF NEW CONCRETE GIRDER UNDER DEAD LOAD OF CAST-IN-PLACE CONCRETE DECK**

NEW EXTERIOR GIRDER	EXISTING EXTERIOR GIRDER	EXISTING INTERIOR GIRDERS
38 KIPS*	38 KIPS*	29 KIPS*

\* INCLUDES 12 LBS./SQ. FT. WEARING SURFACE

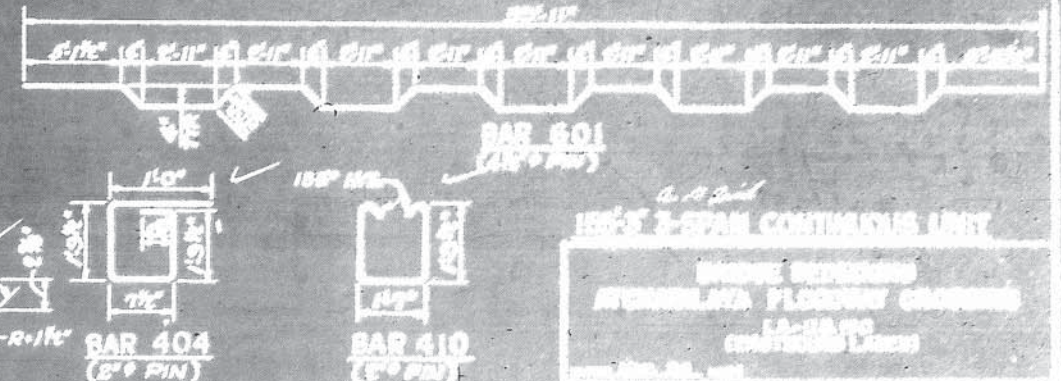

BAR	SIZE	NO. BEAMS	UNIT LENGTH	TOTAL LENGTH	LOCATION
#701	#7	15	2'-0"	30'-0"	CHAPBRGNS
TOTAL #7 @ 26'-0" = 390'-0" @ 26'-0" L.B.					
#401	#6	24	41'-2"	987'-0"	TRANSVERSE STRG
#402	#6	185	2'-2"	367'-0"	"
#403	#6	185	2'-2"	367'-0"	"
#404	#6	15	3'-0"	45'-0"	CHAPBRGNS
#405	#6	15	3'-0"	45'-0"	"
#406	#6	25	2'-0"	50'-0"	"
#407	#6	15	3'-0"	45'-0"	"
#408	#6	15	3'-0"	45'-0"	"
#409	#6	25	2'-0"	50'-0"	CONCRETE
TOTAL #6 @ 26'-0" = 390'-0" @ 26'-0" L.B.					
#401	#6	24	41'-2"	987'-0"	TRANSVERSE STRG
#402	#6	185	2'-2"	367'-0"	"
#403	#6	185	2'-2"	367'-0"	"
#404	#6	15	3'-0"	45'-0"	CHAPBRGNS
#405	#6	15	3'-0"	45'-0"	"
#406	#6	25	2'-0"	50'-0"	"
#407	#6	15	3'-0"	45'-0"	"
#408	#6	15	3'-0"	45'-0"	"
#409	#6	25	2'-0"	50'-0"	CONCRETE

NOTES:  
1. ALL STEEL SHALL BE AISC A36 UNLESS OTHERWISE SPECIFIED.  
2. ALL WELDS SHALL BE E70T-1 FULL PENETRATION WELDS UNLESS OTHERWISE SPECIFIED.  
3. ALL BOLTS SHALL BE A307 UNLESS OTHERWISE SPECIFIED.  
4. ALL NUTS SHALL BE A307 UNLESS OTHERWISE SPECIFIED.  
5. ALL WASHERS SHALL BE A307 UNLESS OTHERWISE SPECIFIED.  
6. ALL ANCHOR BOLTS SHALL BE A307 UNLESS OTHERWISE SPECIFIED.  
7. ALL CAP SCREWS SHALL BE A307 UNLESS OTHERWISE SPECIFIED.  
8. ALL THREADED INSERTS SHALL BE A307 UNLESS OTHERWISE SPECIFIED.  
9. ALL STEEL SHALL BE GALVANIZED UNLESS OTHERWISE SPECIFIED.  
10. ALL CONCRETE SHALL BE 3000 PSI UNLESS OTHERWISE SPECIFIED.  
11. ALL DIMENSIONS SHALL BE IN FEET AND INCHES UNLESS OTHERWISE SPECIFIED.  
12. ALL DIMENSIONS SHALL BE TO FACE UNLESS OTHERWISE SPECIFIED.  
13. ALL DIMENSIONS SHALL BE TO CENTER UNLESS OTHERWISE SPECIFIED.  
14. ALL DIMENSIONS SHALL BE TO EDGE UNLESS OTHERWISE SPECIFIED.  
15. ALL DIMENSIONS SHALL BE TO SURFACE UNLESS OTHERWISE SPECIFIED.  
16. ALL DIMENSIONS SHALL BE TO CENTERLINE UNLESS OTHERWISE SPECIFIED.  
17. ALL DIMENSIONS SHALL BE TO BOLT CENTERLINE UNLESS OTHERWISE SPECIFIED.  
18. ALL DIMENSIONS SHALL BE TO NUT CENTERLINE UNLESS OTHERWISE SPECIFIED.  
19. ALL DIMENSIONS SHALL BE TO WASHER CENTERLINE UNLESS OTHERWISE SPECIFIED.  
20. ALL DIMENSIONS SHALL BE TO ANCHOR CENTERLINE UNLESS OTHERWISE SPECIFIED.  
21. ALL DIMENSIONS SHALL BE TO CAP CENTERLINE UNLESS OTHERWISE SPECIFIED.  
22. ALL DIMENSIONS SHALL BE TO INSERT CENTERLINE UNLESS OTHERWISE SPECIFIED.



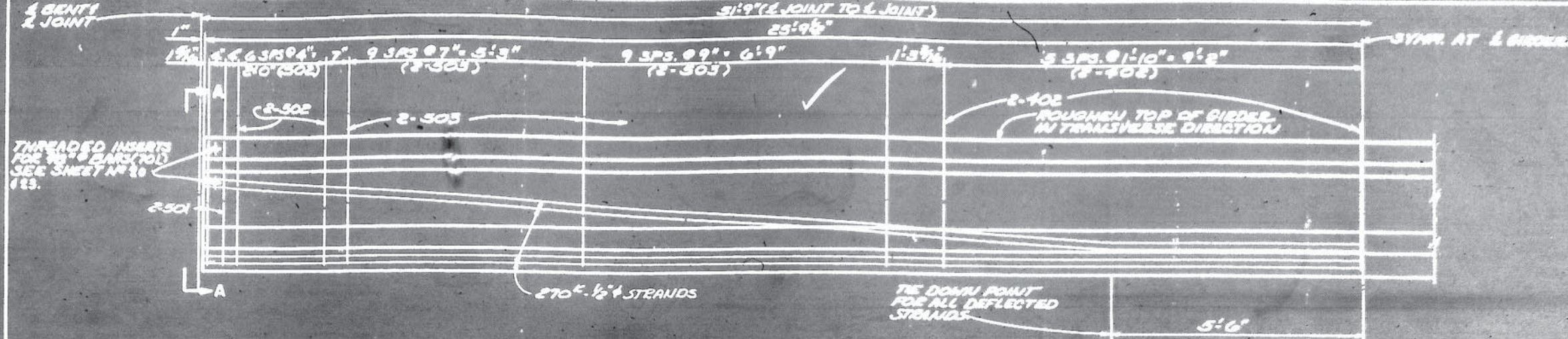

ELEVATION

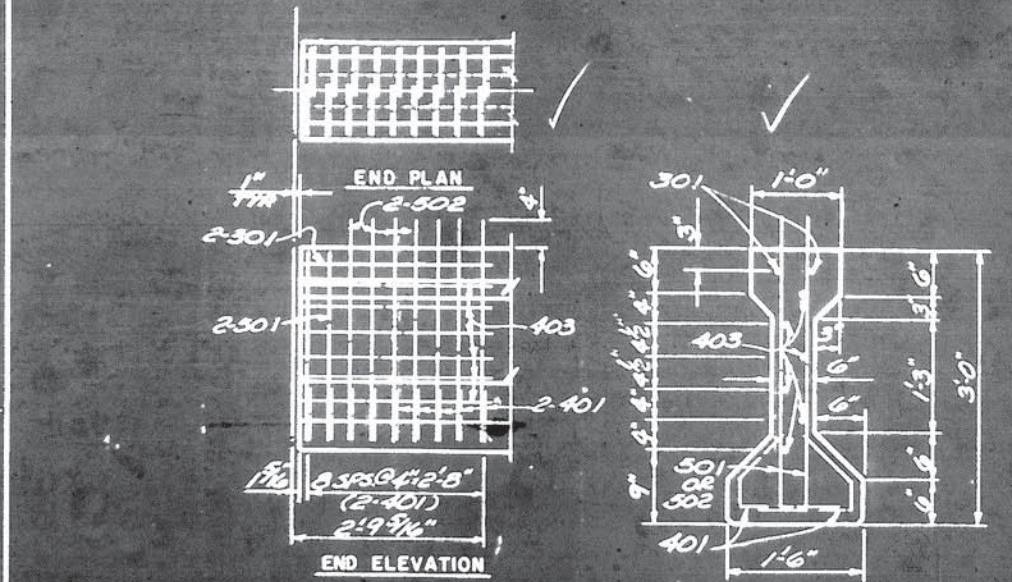

END ELEVATION

SECTION AT END OF GIRDER  
(STRANDS NOT SHOWN)

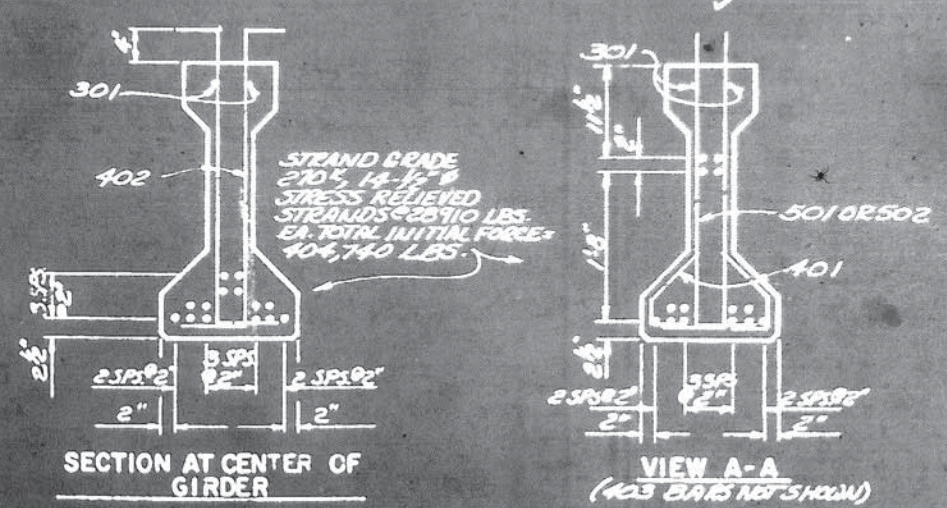

SECTION AT CENTER OF GIRDER

VIEW A-A  
(403 BARS NOT SHOWN)

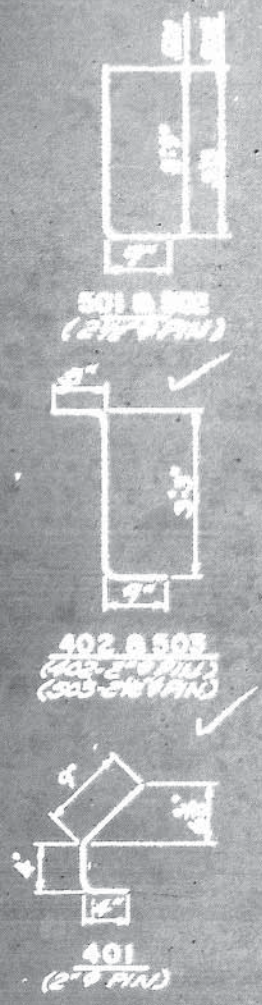

402 & 502  
(2 1/2" x 9 1/2")  
(502 - 20910)

401  
(2" x 9")

F. A. R.	DATE	BY	NO.
WF-02-0400	8-04-00	ST. LANDRY	24

ESTIMATED QUANTITIES (ONE NEW GIRDER)					
BAR	SIZE	NO.	UNIT LENGTH	TOTAL LENGTH	LOCATION
501	#5	8	3'-0"	24'-0"	ENDS OF GIRDER
502	#5	200	3'-0"	715'-0"	SPACES OF GIRDER
402	#5	16	4'-0"	64'-0"	STAIRS
TOTAL BAR WEIGHT - 9750 LBS.					576 LBS.
401	#5	8	3'-0"	24'-0"	ENDS OF GIRDER
402	#5	16	4'-0"	64'-0"	STAIRS
403	#5	16	4'-0"	64'-0"	ENDS OF GIRDER
TOTAL BAR WEIGHT - 9750 LBS.					576 LBS.

NOTE: THE INITIAL FORCE OF THE STRANDS SHALL BE 404,740 LBS. PER GIRDER. THE INITIAL FORCE OF THE STRANDS SHALL BE 404,740 LBS. PER GIRDER. THE INITIAL FORCE OF THE STRANDS SHALL BE 404,740 LBS. PER GIRDER.

CAMER NOTE: THE INITIAL FORCE OF THE STRANDS SHALL BE 404,740 LBS. PER GIRDER. THE INITIAL FORCE OF THE STRANDS SHALL BE 404,740 LBS. PER GIRDER.

PRECISE INDUSTRIES CONCRETE SYSTEMS

INDUSTRIAL PLANNING & DESIGN

ATLANTA, GEORGIA

LA-02-00

DATE: 8/4/00

As BUILTS



DATE	BY	REVISION
8-04-50	ST. LANDRY	25

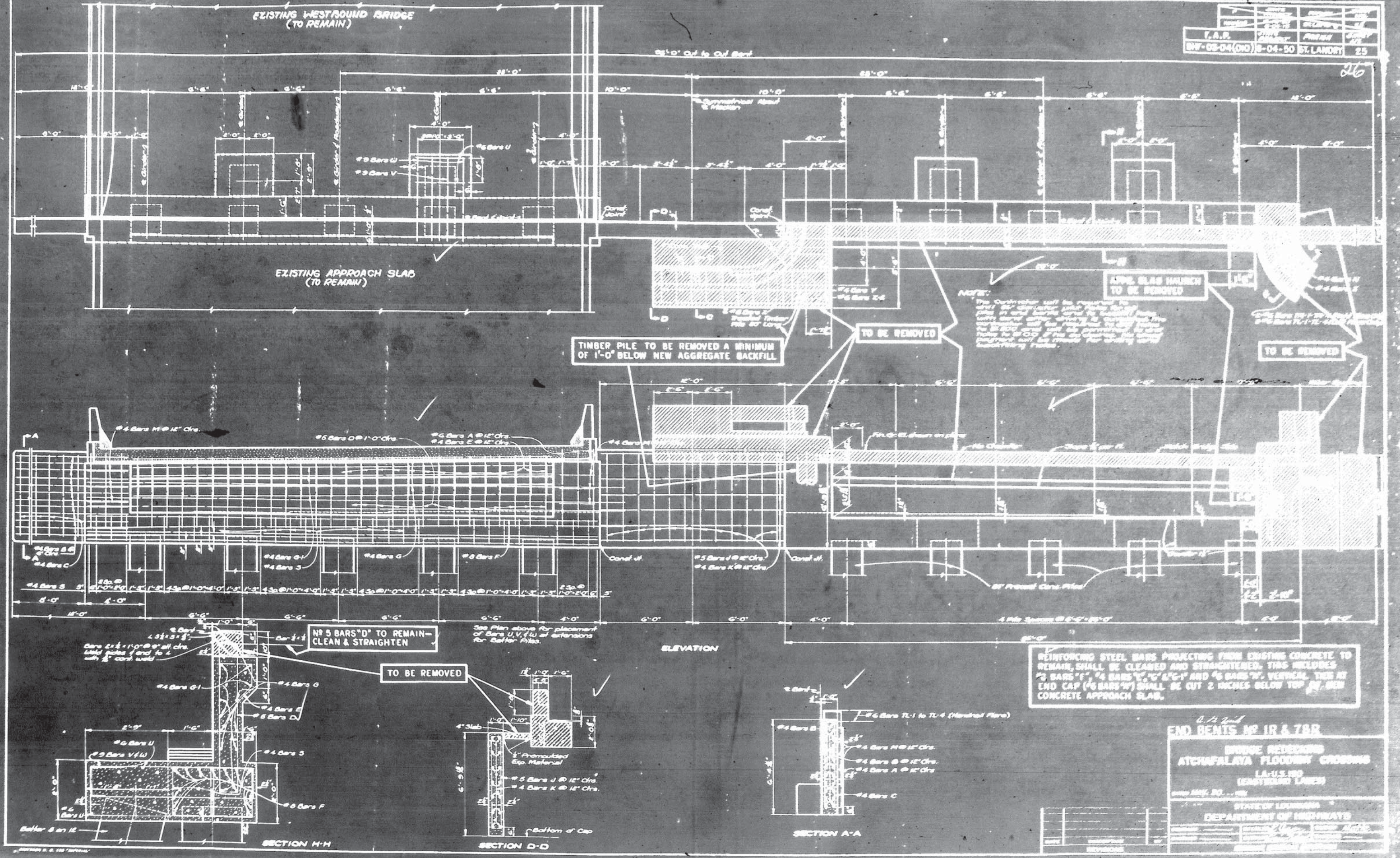

As BUILTS

0.1221  
**END BENTS NO. 1R & 7BR**  
 BRIDGE REPAIRING  
 ATCHAFALAYA FLOODWAY CROSSING  
 LA-US-100  
 (EXISTING LANE)  
 STATE OF LOUISIANA  
 DEPARTMENT OF HIGHWAYS



E.A.P.	DATE DRAWN	DRAWN BY	HEET NO.
NY-02-04(010)	8-04-50	ST. LAUDRY	26

ESTIMATED QUANTITIES (ONE BENT)					
BAR	SIZE	NO. REB.	UNIT LENGTH	TOTAL LENGTH	LOCATION
501	#8	14	2'-0"	28'-0"	LONGIT. - CAP
TOTAL #5 BARS = 166'-0" = 166 LBS.					
501	#8	3	12'-10"	36'-0"	STIRRUPS - C.L.
505	#8	5	8'-0"	40'-0"	CAP
TOTAL #5 BARS = 146'-0" = 146 LBS.					
401	#8	20	7'-1"	142'-0"	STIRRUPS - CAP
402	#8	3	6'-1"	18'-0"	STIRRUPS - CAP
403	#8	2	10'-0"	20'-0"	"
404	#8	16	11'-0"	176'-0"	STIRRUPS - C.L.
405	#8	6	3'-0"	18'-0"	STIRRUPS - C.L.
406	#8	4	8'-1"	32'-0"	"
407	#8	3	15'-1"	45'-0"	STIRRUPS - C.L.
408	#8	3	8'-0"	24'-0"	CAP
TOTAL #8 BARS = 624'-0" = 624 LBS.					
DEFORMED REINFORCED STEEL = 946 LBS.					
CLASS A CONCRETE (BENT) = 3.06 CU. YDS.					

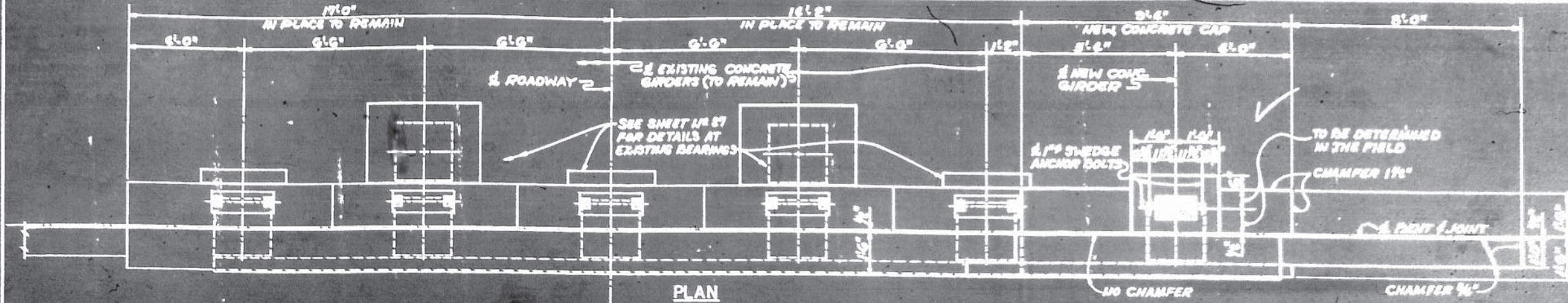

PLAN

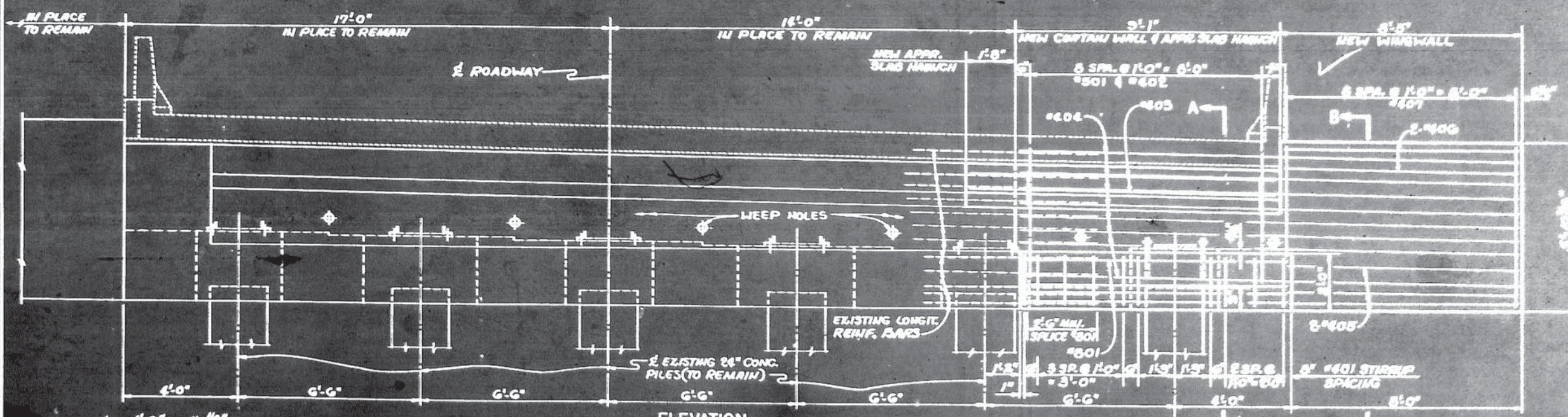

ELEVATION

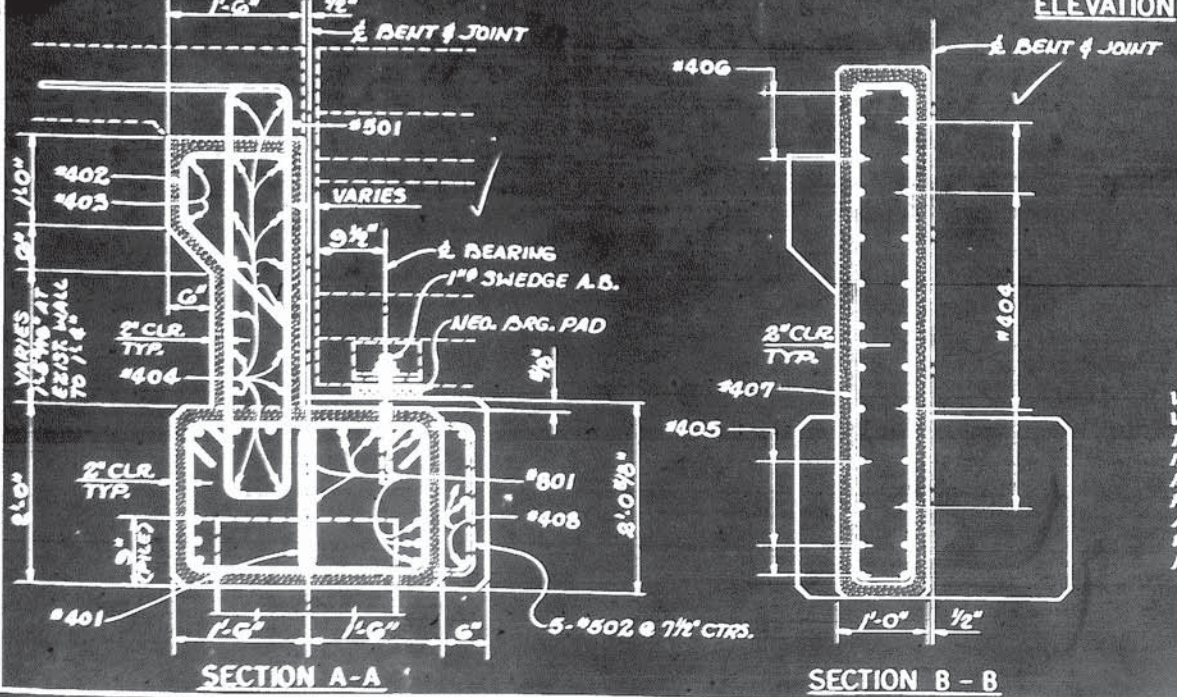

SECTION A-A

SECTION B-B

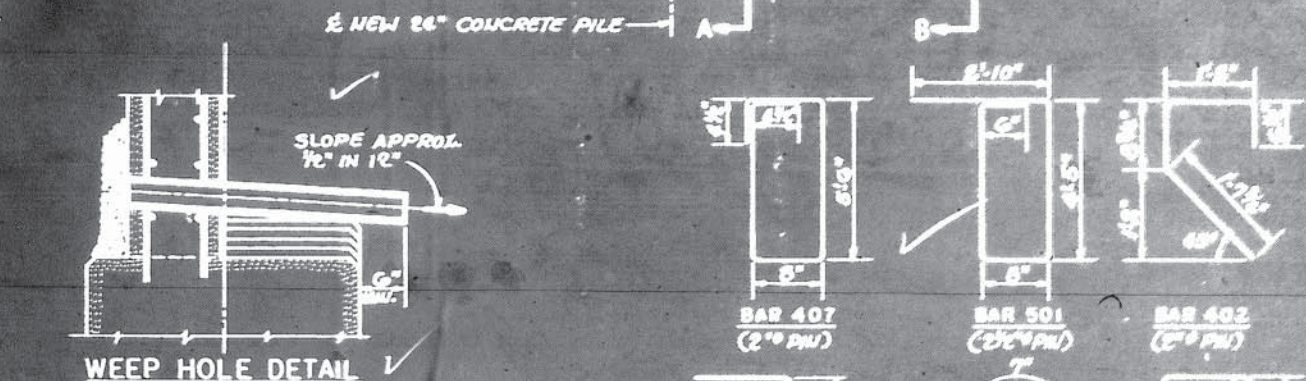

WEEP HOLE DETAIL

WEEP HOLE SHALL CONSIST OF A 3" P.V.C. PIPE WITH A 12" SQUARE SCREEN OF 4-4 MESH GALVANIZED HARDWARE CLOTH, 25 GAGE, PLACED OVER THE INSIDE END. PLACE 2 CU. FT. OF COARSE AGGREGATE BACKFILL AROUND WEEP HOLE. IN EXISTING CONCRETE PIPE SHALL BE PLACED IN DRILLED HOLES WITH AN APPROVED NON-SHRINKING EPOXY GROUT. NO DIRECT PAYMENT, COST TO BE INCLUDED WITH OTHER ITEMS.

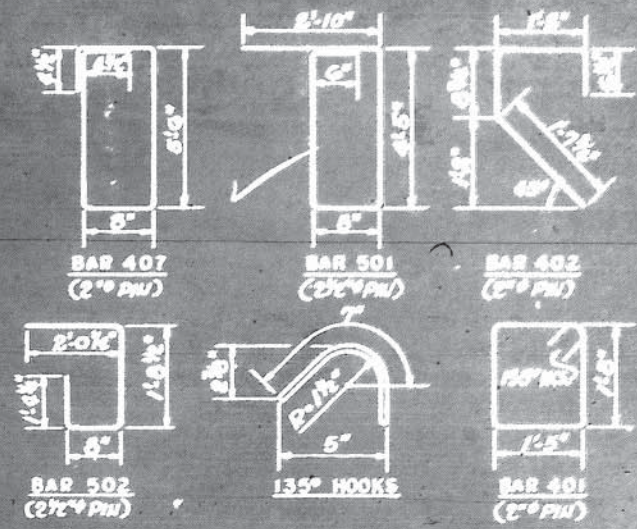

END BENTS NO. 12 & 13

ENGINE: [Signature]

ARCHITECT: [Signature]

CONTRACT NO. 11-05-10

DATE: 8-04-50

SHEET 2 OF 2